



# **LISA**

## ***High Luminosity Spectrograph***

# **User Guide**

### **Shelyak Instruments**

Les Roussets

38420 Revel / France

Phone: +33.476.413.681

<http://www.shelyak.com>

Email: [contact@shelyak.com](mailto:contact@shelyak.com)

Ref. DC0012A



## Table of Content

1	Introduction.....	4
2	Out of the box.....	5
3	Overview of the LISA.....	5
3.1	The Basic Elements.....	5
3.2	Calibrating the spectra.....	7
3.3	Features & performance.....	10
3.4	Accessories (optional elements).....	10
4	Mechanical interfaces.....	10
4.1.1	Telescope interface.....	10
4.1.2	CCD camera interface.....	12
4.1.3	Guiding camera interface.....	13
5	Starting & tuning.....	13
5.1	Setup your guiding camera.....	14
5.1.1	Installation.....	14
5.1.2	Guiding camera focus.....	14
5.2	Setup your acquisition camera.....	16
5.2.1	Installation.....	16
5.2.2	Focus.....	19
5.3	Grating angle.....	20
5.4	Checking the calibration screen.....	22
6	In the field.....	25
6.1	Operation to be done during daylight.....	25
6.1.1	Mounting the LISA on the telescope.....	25
6.1.2	Check / Fine tune adjustments (focus guiding, focus LISA acquisition, focus telescope.....)	25
6.2	Standard acquisition procedure.....	25
6.2.1	CCD master frames.....	25
6.2.2	Calibration frames.....	26
6.2.3	Object frames.....	27
6.2.4	Reference star spectrum.....	28
7	Processing.....	28
7.1	Preprocessing.....	28
7.2	Geometry.....	28
7.3	Remove background.....	28
7.4	Combining spectra.....	28
7.5	Extracting spectra.....	29
7.6	Wavelength calibration.....	29
7.7	Instrumental response.....	29
7.8	Software.....	30
8	Spectroscopy: introduction.....	31
8.1	In the beginning.....	31
8.2	Different types of spectra.....	31
8.3	Message from light.....	32
8.4	Effective temperature and spectral types.....	33
8.5	Spectral class.....	33
8.6	Chemical composition and metallicity.....	33
8.7	Doppler Effect.....	34
8.8	Conclusion.....	34
9	Troubleshooting / Support.....	35

10	References.....	36
10.1	Books.....	36
10.2	Web links.....	50
10.2.1	General.....	50
10.2.2	Software.....	50
11	Appendix.....	51
11.1	Appendix A - Add Automatic Calibration Module.....	51
11.2	Appendix B - Opening / closing the LISA.....	57
11.3	Appendix C - Switching from VIS to IR.....	68
11.4	Appendix D - Switching from IR to VIS.....	72
11.5	Appendix E - Tuning the grating angle.....	72
11.6	Appendix F - Tuning the calibration screen.....	75
11.7	Appendix G - Aligning the guiding mirror.....	77
11.8	Appendix H - Focusing & aligning the collimator.....	80
11.9	Appendix I - Factory tuning process.....	82

# 1 Introduction

This document will help you to use your LISA high luminosity, low resolution, spectrograph.

We consider that you are already familiar with spectroscopy basics and that you are able to control your telescope and your CCD camera.

We start with a presentation of the instrument, then we'll describe how to prepare it, and and we'll finish with its using in the field. You'll find also in appendix how to tune all the parts of the instrument, as it has been done in the factory.

LISA can be used in two different configurations : the standard one is VISIBLE mode. This is the one we describe in this document. The other one is INFRA-RED. You will find in appendix the differences between two configurations and how to switch from one to another (this must be done by experienced user only).

Keep in mind that the spectrograph must be tuned and prepared during daylight in a room : do not go straight towards the telescope and wait for night !

Starting in spectroscopy can be impressive, since there are several elements to put under control. But thanks to this guide, you will see that none of them is very complex, and just some rigour is required to make things working together.

We hope that you will enjoy spectroscopy with LISA. Join the increasing Shelyak Instruments users and amateur spectroscopist community on Spectro-L (<http://groups.yahoo.com/group/spectro-l/>) to keep us informed of your progress and results and to look for new projects or observing campaigns. But most importantly, enjoy spectrography!

Olivier Thizy ([olivier.thizy@shelyak.com](mailto:olivier.thizy@shelyak.com))

François Cochard ([francois.cochard@shelyak.com](mailto:francois.cochard@shelyak.com))

## 2 Out of the box

When you receive the your LISA, you should find these elements :

- The LISA spectrograph
- A tool set, if you need to tune the instrument
- The CCD camera adapter
- Documentation
- Depending on your order, some optional elements (Calibration module, IR conversion kit...)

## 3 Overview of the LISA

LISA is a luminous slit-based spectrograph (F/5), designed to observe faint or extended targets. It is mounted directly on the telescope, and includes a guiding feature.

### 3.1 The Basic Elements

To optimize the use of your LISA spectrograph, it is important that you keep in mind the key principles of the instrument. Here is a short description of its interior.

The LISA is made of two main parts : on top, there is the guiding unit (which includes parts dedicated to calibration, see blue section in figure 1). In bottom, there is the spectrograph by itself (green section in figure 1).

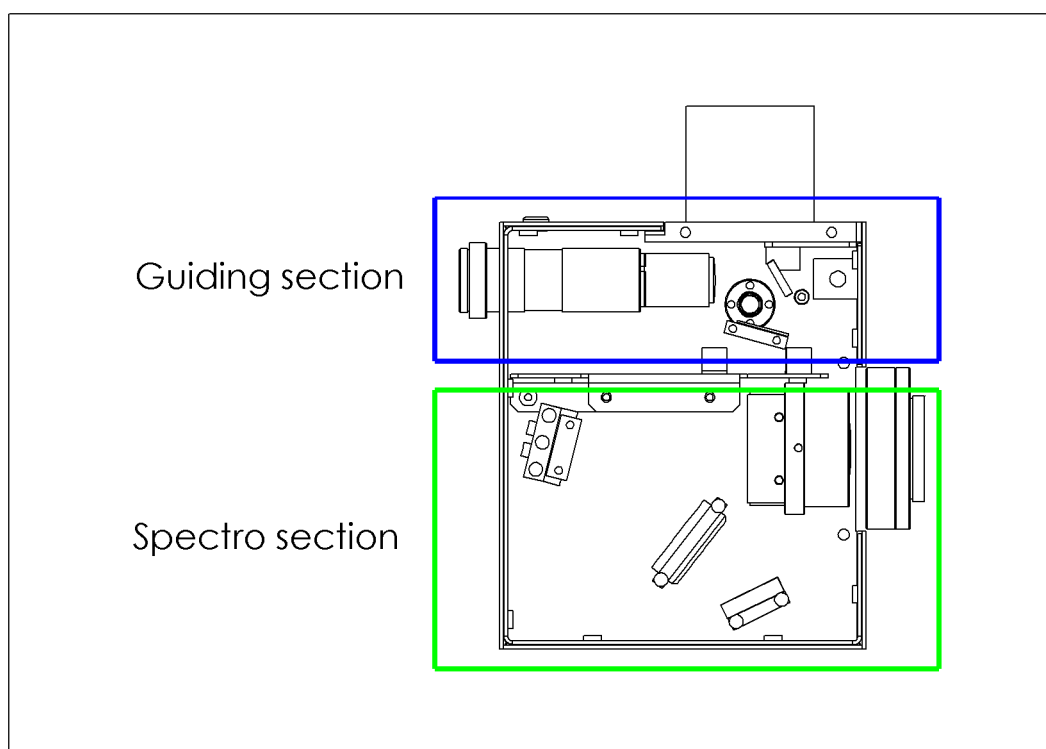

Figure 1 : guiding and spectro sections

Figure 2 is a drawing showing main elements of the instrument. There are three mechanical links to external elements : the telescope mounting, the guiding port and the spectrum aquisition port.

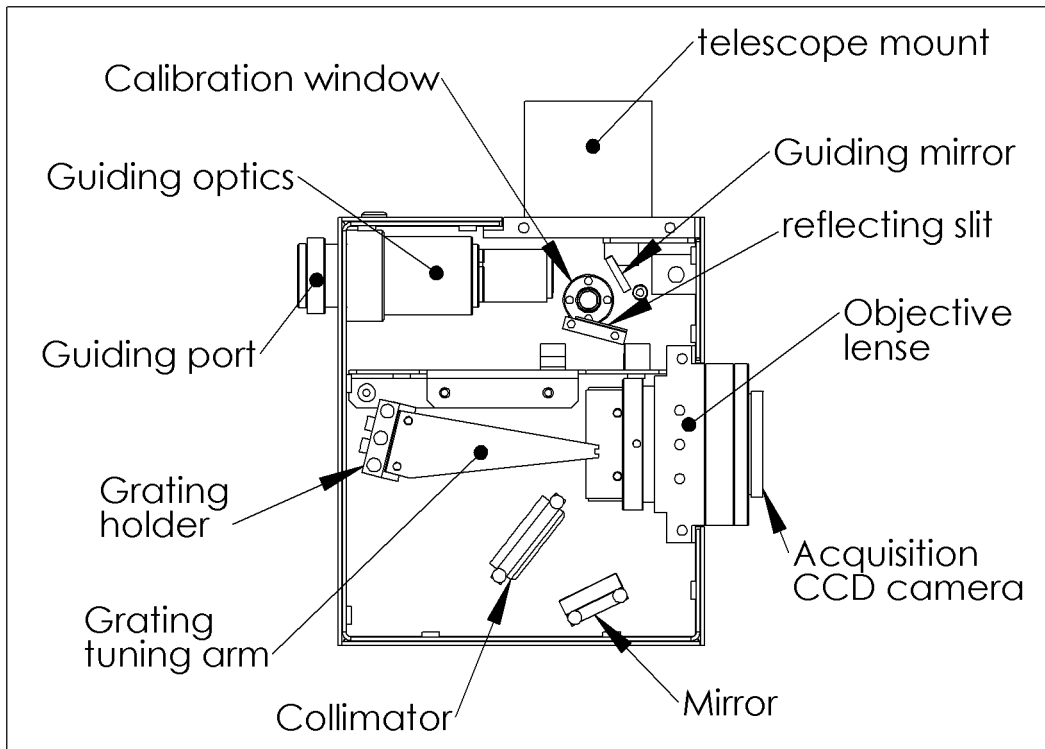

Figure 2 : LISA main elements

Figure 3 describes in detail the light path for both spectrograph and guiding section. Light beams (cones and cylinders) are sketched :

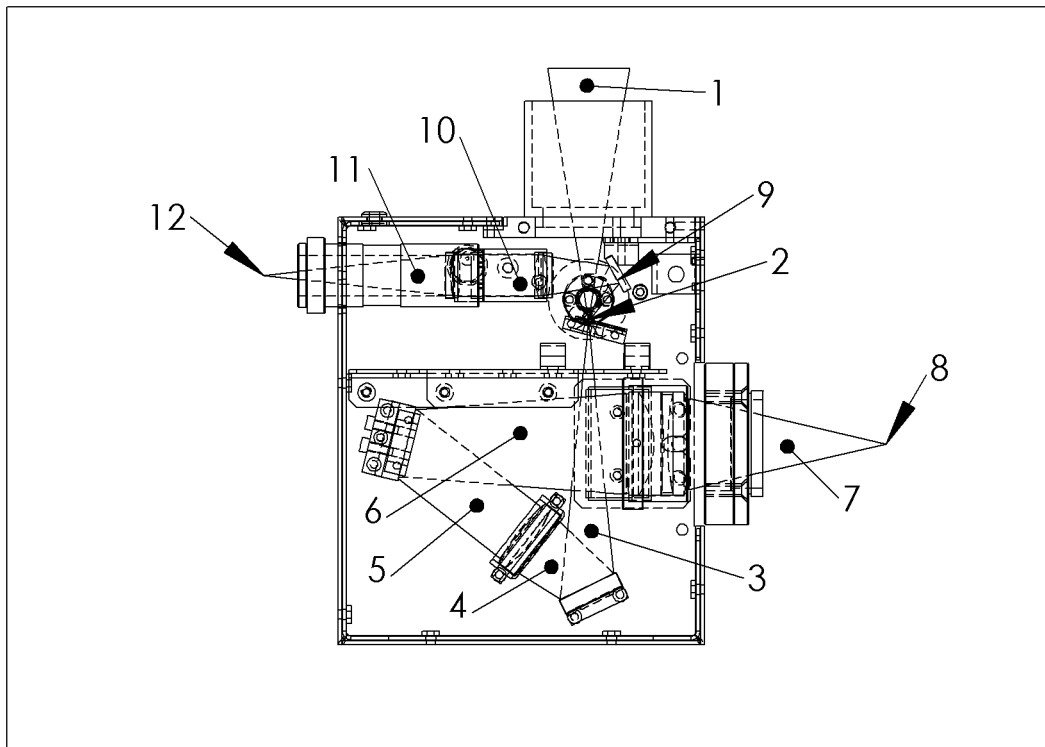

Figure 3 : LISA light path

The star light is focused by the telescope (1), goes through the slit (2), is reflected by the mirror (3 & 4), is transformed in a parallel beam (5) by the collimator. Then, it is diffracted (6) by the grating, goes through the objective lens, and converges (7) towards the CCD sensor (8).

For guiding section, all light coming from telescope (1) which does not pass through the slit (2) is reflected towards the guiding mirror (9), sent to the guiding optics (10), and refocused (11) to the guiding camera sensor (12).

The focal length of the collimator is 130mm. The focal length of the camera lens is 88mm. This means that the slit image will be multiplied by  $88/130=0.68$  on the CCD.

The focal length for both guiding doublets are the same (75mm). Then, the ratio between object in telescope focale plane and image in guiding camera is 1:1.

## 3.2 Calibrating the spectra

Calibration the spectra wavelength is necessary for scientific usage of your data, as well as flat spectra to correct the instrumental response curve of the whole instrumentation.

The LISA spectrograph includes some features to make these calibration easy and precise :

- A calibration window is available on LISA side, to send calibration light in the instrument.
- A white screen, controlled by an electro-magnet can be moved to send calibration light to the slit. The electro-magnet is supplied by an electronic circuit which prevents any heat dissipation.
- When this screen is in front of the slit, it prevents star light to enter in the spectrograph. Then, you can make calibration acquisitions even when the telescop is pointing a star.

In the drawings hereafter, you can see the light opening on the spectro side (yellow), the mobile white screen, the electro-magnet and the electronic PC board (green)

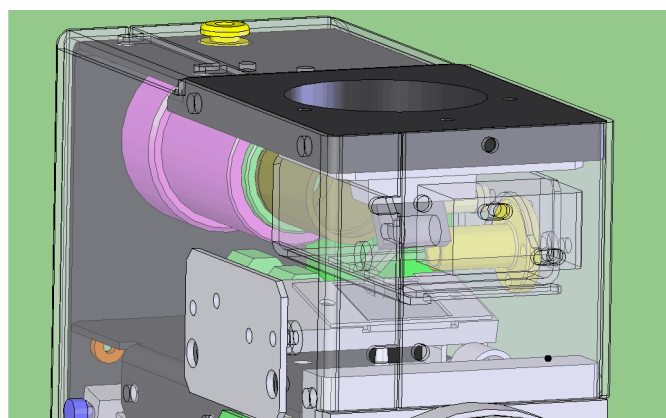
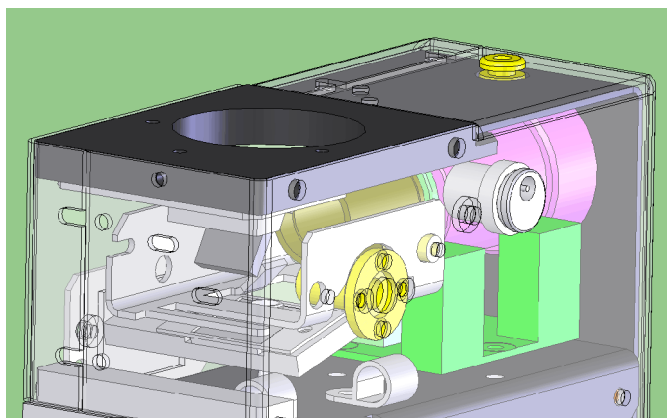

- An optional calibration module is available : it enlights the calibration window with white light (halogen lamp) for flats and Neon lamp for calibration.

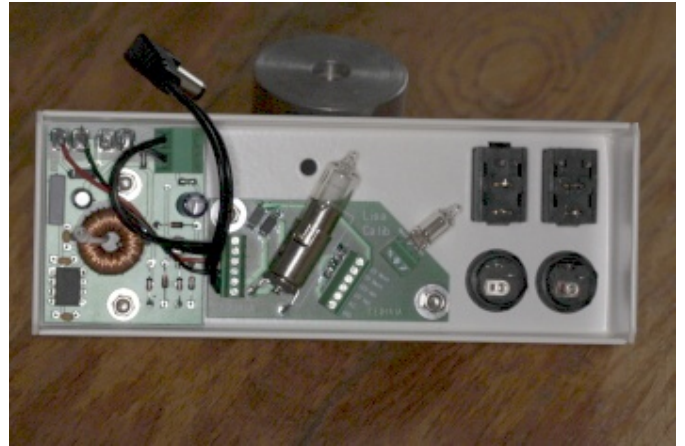

### **3.3 Features & performance**

Visible mode spectral domain: 400-700nm.

Near-IR mode spectral domain: 650nm-1 $\mu$ m (CCD cameras usually limit around 950nm).

Resolving power:  $\sim$ 600-1000 (depends on slit and mode).

Slit: 15 $\mu$ m, 19 $\mu$ m, 23 $\mu$ m or 35 $\mu$ m (optional slit: 19 $\mu$ m hole; 50 $\mu$ m, 75 $\mu$ m, 100 $\mu$ m slit).

Slit length is 4mm.

Backfocus telescope : 41mm (distance from the top flat face of the LISA to the slit).

Backfocus CCD camera : T-mount standard (54,85mm).

Backfocus guiding camera : C-mount standard (17,5mm).

Connecteur 12V de calibration : 2.5mm, positive in the center.



### 3.4 Accessories (optional elements)

Shelyak Instruments can provide you with some optional elements, to complete your LISA setup :

- Calibration module (see above)
- IR conversion kit (to change the observed bandwidth to 600-950nm)
- Several CCD camera adapters
- Eyepiece holder
- For any other specific need, do not hesitate to contact us

## 4 Mechanical interfaces

### 4.1.1 Telescope interface

LISA front plate includes a standard T-mount thread (M42x0.75mm). Backfocus is 41mm (distance from the top flat face of the instrument and the slit position).

For your convenience, the LISA is shipped with a M42/2" adaptor. This is the simplest way to mount it on a telescope.

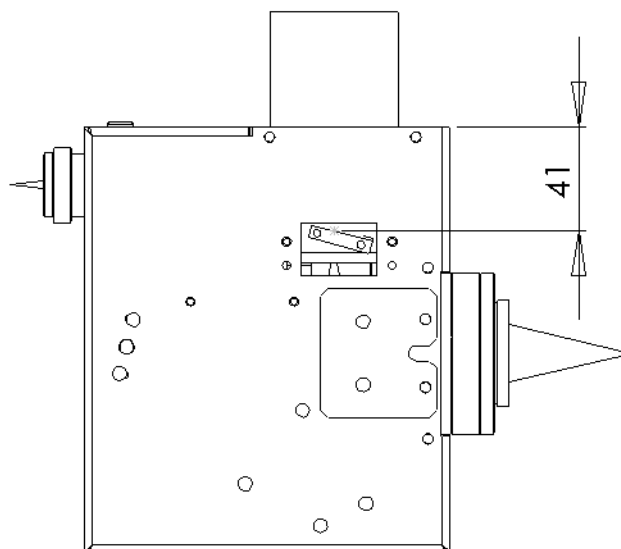
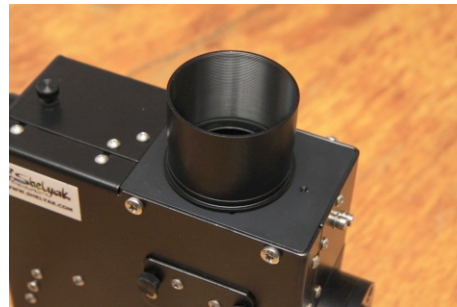
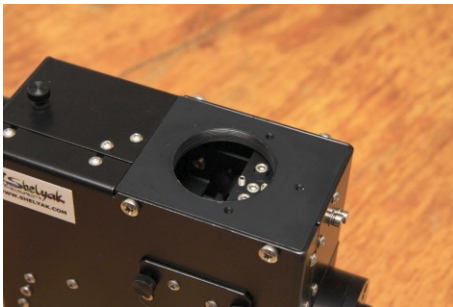

## 4.1.2 CCD camera interface

The acquisition CCD camera is mounted on the camera interface.

LISA is shipped with an adaptor for QSI cameras ('ws' body profile).

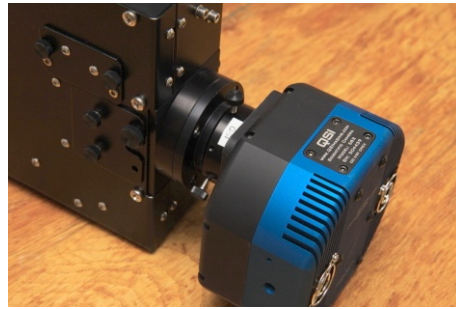
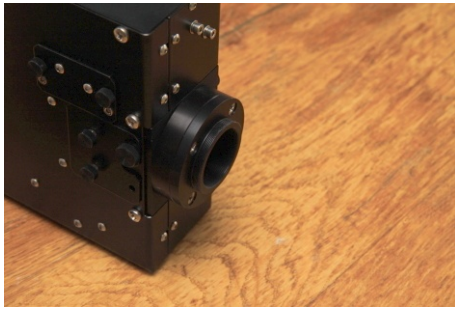

Depending on your camera, we can provide different adaptors. Most CCD camera have a T-mount thread, and this is the best way to attach it on the LISA. All Lhires III CCD camera adaptors are compatible for your LISA spectrograph as both instruments have the same spectrum port backfocus.

LISA adaptor have two threads :

- Internal thread is M35x1mm. It is used for Shelyak adaptors (such as the QSI one).
- External thread is T-mount standard (M42x0.75mm, 54.85mm backfocus). It can be used for standard adaptors, or to mount directly a DSLR (with T-ring).

The backfocus of the T-mount standard is 54.85mm from flat face to the focus point. The tuning range for LISA allow to put the focus plane (CCD plane) at +/-5mm of this position.

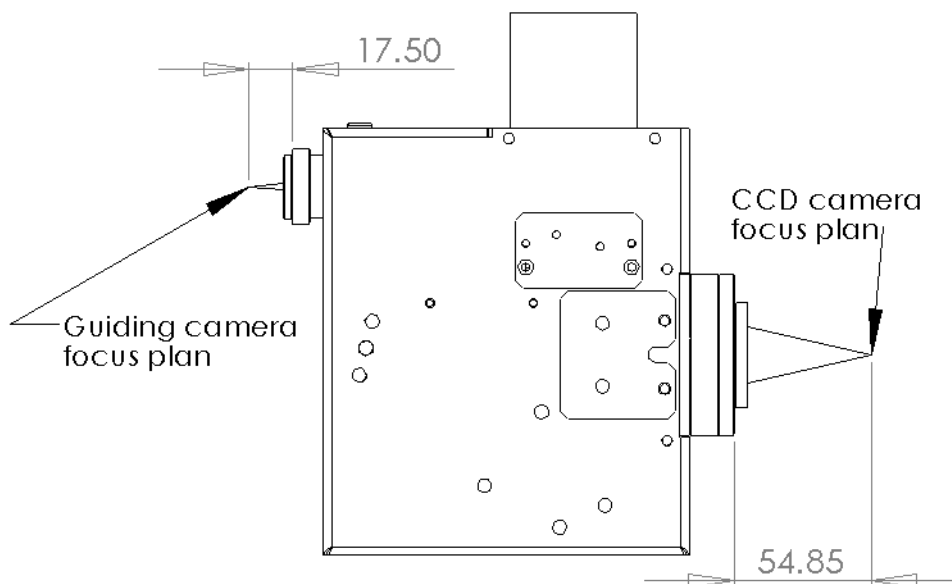

### 4.1.3 Guiding camera interface

The guiding port is a C-mount (1" diameter, 32 thread / inch, backfocus 17.5mm) used by several guiding camera and is a standard among video camera.

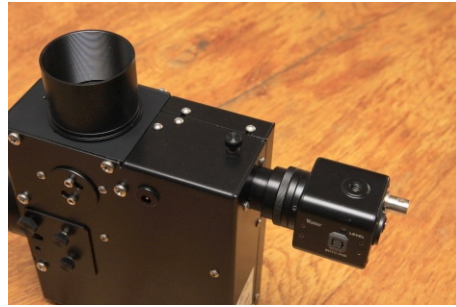
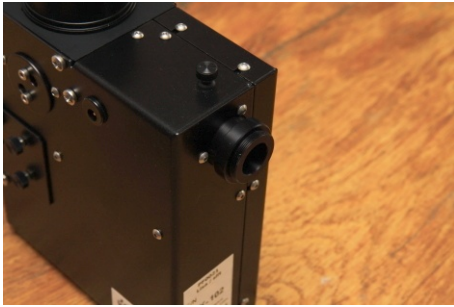

## 5 Starting & tuning

This is now time to start working with your LISA. We'll describe how to install cameras on it, tune it, and check its behavior is nominal. Important : all this task can be done during daylight. Install yourself in good conditions, with a large table and enough light.

It is preferable to do these operations in relative darkness, to prevent any light pollution when the spectrograph is open.

### 5.1 Setup your guiding camera

In this section, we'll install the guiding camera on the LISA. We consider that you know how to use and control it.

#### 5.1.1 Installation

Untighten the locking screw of the guiding port :



Remove the guiding camera holder, and screw it carefully on the camera. There is no tuning at this stage : the lense are put at the right position for the guiding camera by mechanical design.



Slide the camera with its holder in the LISA. Put the camera parallel to the LISA chassis. Put it roughly at the same position as the picture :



### 5.1.2 Guiding camera focus

Put a diffuse paper in front of the telescope mount, or move the telescope mount towards some diffuse light. Take a guiding image (choose the exposure time to prevent any saturation). You should see an horizontal line, eventually very large. This line is the slit :

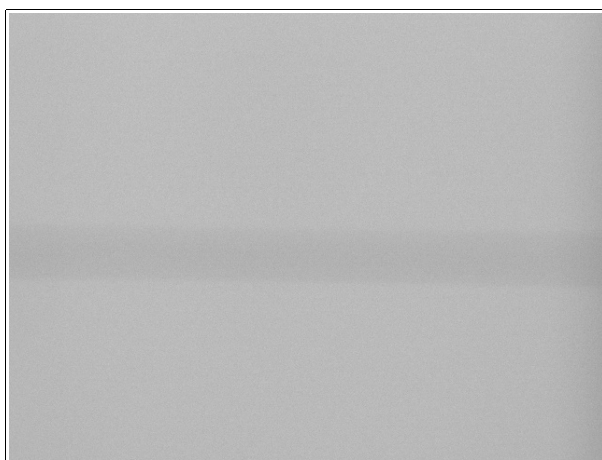

Move slightly the camera in order to get the best focus. You'll see that when you turn the camera, the slit rotates on the screen. It must be put horizontally.

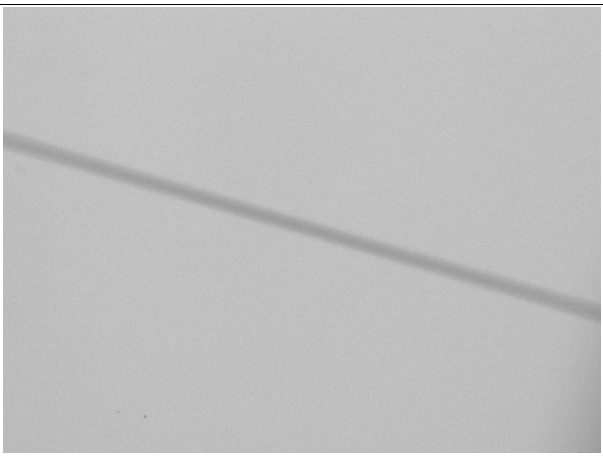
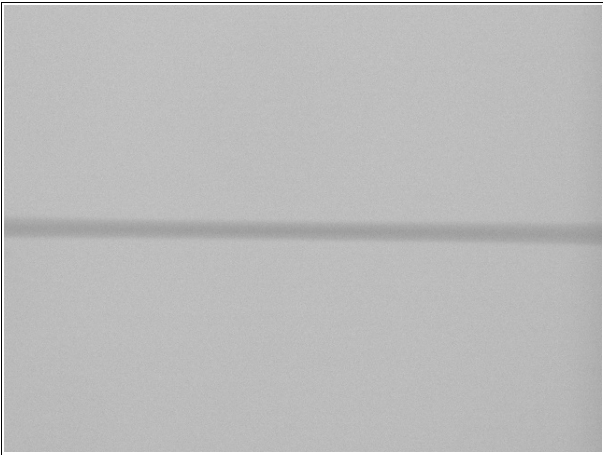

<b>Wrong position of the guiding camera</b>	<b>Good position of the guiding camera</b>
	

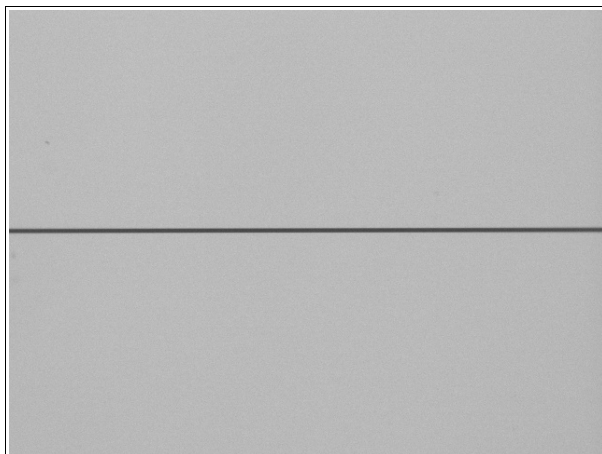
Tighten the top screw to lock the guiding camera in position. At the end, you should have this image on the computer screen :

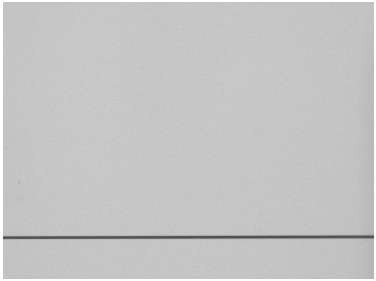
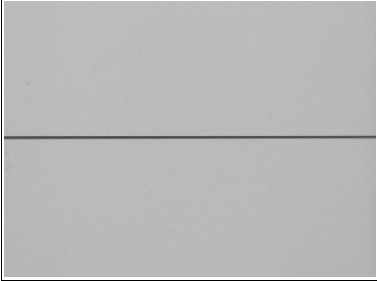

Do not remove the guiding camera from the LISA until you install it on the telescope. If you have to remove the camera from the LISA, you will have to re-focus it.

The guiding mirror alignment have been done in our factory before shipment. Then, the slit should be right in the middle of the image (vertically). If this is not the case, you may retune this point. It is described in appendix D.

Not acceptable (too low)	Correct alignment	Not acceptable (too high)
		

## 5.2 Setup your acquisition camera

In this section, we consider that you already know how to use and control your CCD camera. We use the example of a QSI camera.

### 5.2.1 Installation

Mount your CCD camera on the LISA spectrograph, with the proper adaptor to put the CCD plane at the nominal position (54.85mm from flat face of T-mount).

Put the camera ring on the camera :



Put the LISA ring on the LISA :

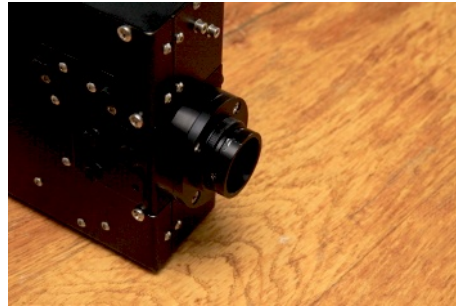
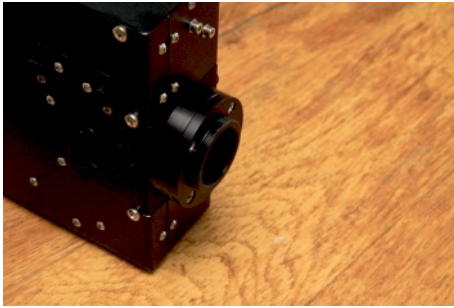

and assemble the camera on the LISA. Make it right parallel to the LISA body (the long side of the CCD chip must be parallel to the height of the LISA), and tighten securely the three screws



Switch on your camera and your acquisition setup (PC, acquisition software...).

Remove the cap from the telescope adaptor, to let natural light enter in the spectrograph.

Take an image with 1 second exposure. You should get your very first spectrum !

Based on this first picture, adapt the exposure time to prevent any saturation (few seconds is usually enough).

If necessary, fine tune the camera orientation, in order to have a spectrum perfectly horizontal in the image.

### **5.2.2 Focus**

The spectrum is probably not well focused. If possible, use from now on an energy-saver lamp : it has some very bright and thin lines that will be very useful to tune the instrument. You can also use any calibration lamp if you have one. Of course, if you have the integrated calibration module, switch on the Neon lamp.

Open both doors on LISA sides : just remove the big screws (one per door), and slide them gently towards the camera.

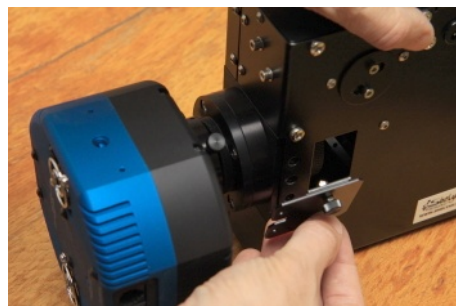
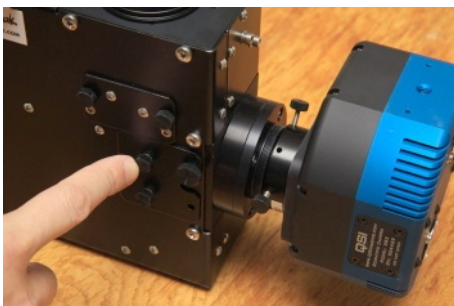

Untighten the white plastic screw on the side. This screw is to lock the main optics in position.

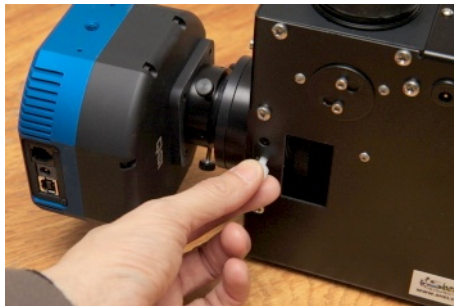

You can now move the LISA main optics, with one finger in each door opening. Take regular images with the camera and rotate the lens in the direction that improves the focus. Bright lines must become thinner and thinner, brighter and brighter.



Once you have found the approximate position for the lens (optimal focus), take some time to fine tune it. The most efficient way is to measure the Full Width Mid-Height (FWMH), and make it the smaller possible.

You can calculate the theoretical FWHM of lines for your setup. The line in the image is the image of the slit, multiplied per 0.68 . Optimal width is to have lines of about 2.5 pixels wide.

Let's take an example : in our configuration, the slit is  $35\mu\text{m}$ . The CCD pixels are  $9\mu\text{m}$  large.

The slit image will be  $35 \times 0.68 = 23.7\mu\text{m}$ , which is 2.6 pixels ( $23.7 / 9$ ).

This means that in the optimal focusing position, the FWHM should be about 2.6 pixels wide. In practice, this optimal case will be hard to get; a FWHM less than 3 pixels (25% more than 'ideal') is a good result.

To get to this resolution, the accuracy required on the lens rotation is about 1/10th of a turn (1/10mm).

Tighten the plastic screw (main lens locking).

Do not remove the CCD camera from the LISA until you install it on the telescope. If you have to remove the camera from the LISA, you will have to re-focus it (fine tuning only).

### 5.3 Grating angle

The grating angle have been tuned in our factory before shipment. This tuning is very sensitive to get the best wavelength bandwidth & quality. The simplest way to check this point is to take a spectrum of the Neon (with camibration module or with external Neon lamp). Focus carefully the spectrum and adjust the exposure time to prevent any saturation. You should have something very close to this (for this picture, we've used the tuning slit, with  $19\mu\text{m}$  hole, and a QSI583 camera):



In this Neon spectrum, you can see the special pattern (5 lines) around Ha (6563A) :

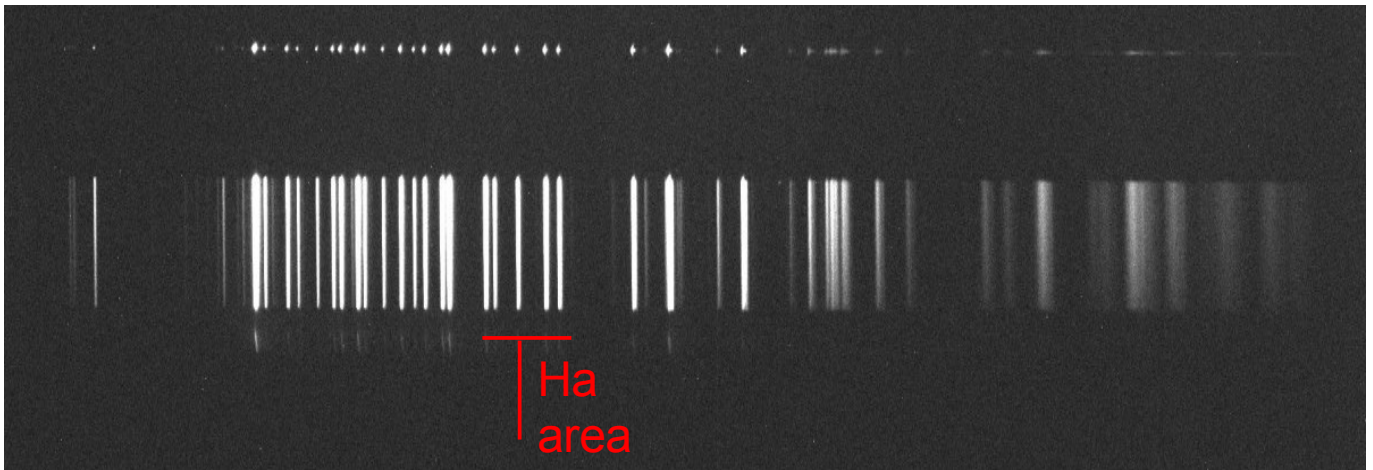
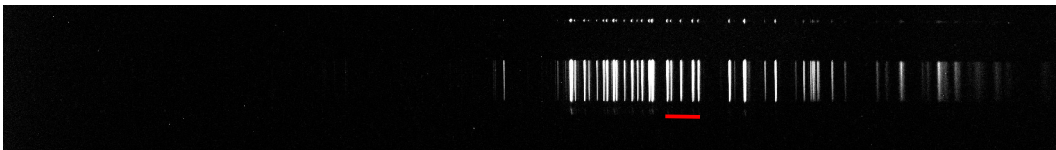

If the spectrum is not positioned conformly to this image, see in Appendix E how to correct this (this must be done by an experienced user).





Depending on your CCD chip, the positioning of the spectrum should be close to this one :

## 5.4 Checking the calibration screen

We have seen in practice that the LISA spectrograph is rather stable. Still, to get the maximum accuracy in calibration, it is sometimes critical to be able to perform calibration while the LISA spectrograph is mounted at the telescope. For this, a small window is available on the side (opposite side of the slit). In addition, a small white screen can be moved electrically in front of the slit.

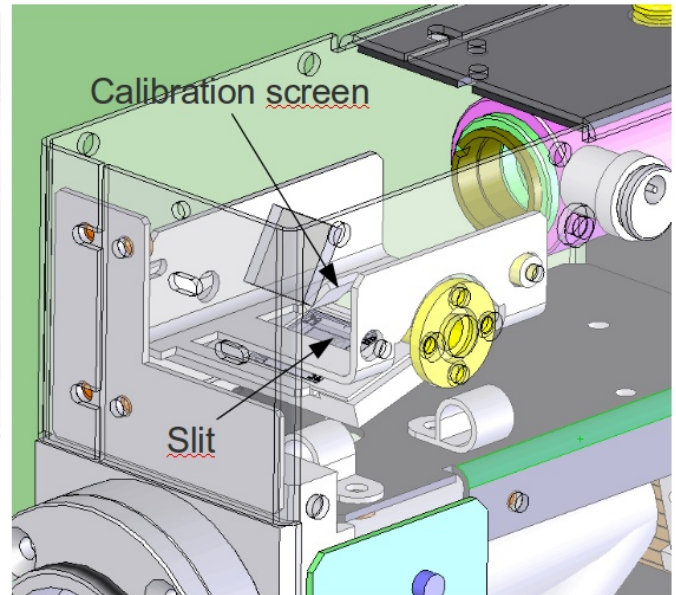
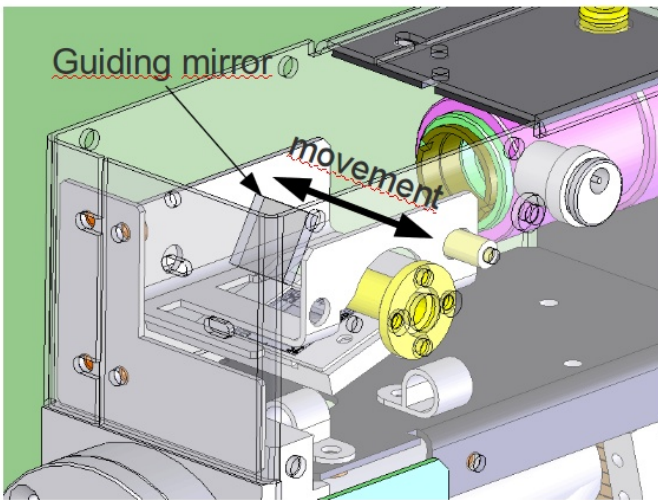

You should check that calibration screen works properly before installing the spectrograph on the telescope. For that, plug a 12V power supply. You should hear a « click » sound, that confirms the electromagnet is Ok. By looking from telescope light entrance, you can see the screen moving in and out when you supply and remove 12V.



Note that an electronic board is inside the LISA spectrograph to send a short pulse to activate the screen, then reduce the voltage to prevent heat dissipation.

Untighten partially the two screws of the calibration window cover :

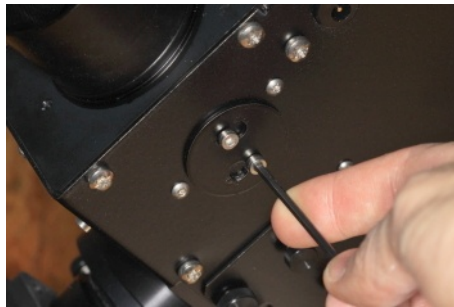

Remove the cover, by rotating and pulling it. You can see the calibration window (clear window, ~10mm diameter).



You can inject some light through this window (tungsten lamp, neon lamp, energy saver lamp...), and take an image : you'll have the spectrum of this calibration lamp. This spectrum must be roughly homogeneous along the slit. If this is not the case, you could improve the electro-magnet tuning (see appendix F).

For instance, here is Halogen lamp spectrum made through the calibration channel :

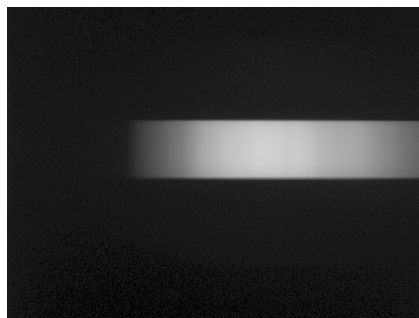

At the end, replace the cover, and tighten smoothly the two screws.

Shelyak Instruments can provide an optionnal device to get white (halogen) and neon light, in order to remotely control the LISA. Mounting this device is described in appendix A.

## 6 In the field

Once you've made all adjustments of the instrument, you're ready to acquire your first star spectra... This section describes the operations to do at every observation.

### 6.1 Operation to be done during daylight

As often in spectroscopy, part of the preparation operations can be done during daylight - it's even preferable ! We consider that your telescope is ready, and you CCD camera as well.

#### 6.1.1 Mounting the LISA on the telescope

Be sure that the instrument is strongly attached to the telescope using the 2" (50.8mm) and, if required, a focal reducer or a barlow to bring your telescope F/ ratio to F/5.. If you have a Schmidt-Cassergrain Telescope, you could use a F/6.3 focal reducer and a SCT T adapter; make sure to use longer distance between the LISA and the focal reducer to get the required F/5 input to the spectrograph. Secure it so it can't fall down. Check the total weight capacity of your mount if needed.

Align the spectrograph in order to have the slit parallel to the RA movement. If you plan to observe low on southern horizon, it may be worthwhile to align on the Dec movement as the turbulence is mainly toward that axis and the refraction effect is also on the vertical axis.

And of course, balance your overall setup very carefully.

#### 6.1.2 Check / Fine tune adjustments (focus guiding, focus LISA acquisition, focus telescope...)

During dawn time or using a lamp in front of the telescope, check the position of the slit on your guiding camera. Record this position on your guiding screen.

Check the focus by taking a calibration (Neon) spectrum. Measure the FWHM (Full Width Half Max) of a line near your camera chip center to ensure it close to what you had during the instrument setup.

### 6.2 Standard acquisition procedure

#### 6.2.1 CCD master frames

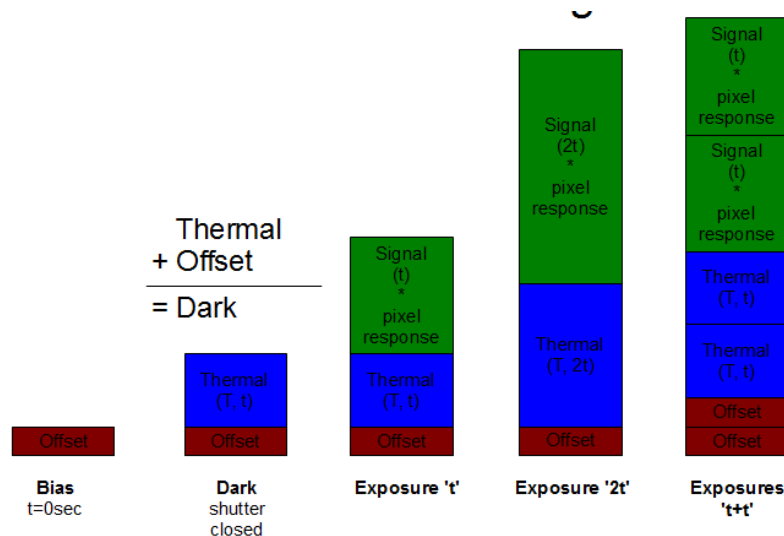

If you use a CCD camera, each image will be affected by the electronic. Several defect can actually be removed using Bias and Dark frames.

To avoid negative signal digital conversion, CCD manufacturers add a fix offset on the analog signal which is called **Offset or Bias**. Any data readout from the CCD chip include this offset. This offset is fairly stable and once you have a master Bias frame, you can keep it for long time. You can make one again once per year approximatly. It is also not too much temperature dependant. Because it is very stable, you can improve your data by taking a long series of bias frame (around 100 exposures) and perform a median average to create a mooth master bias frame for your camera. Median average is better than a simple average as it will totally remove out of the ordinary defect on some of your images, such as cosmic rays for example.

CCD chip have a tendancy to build electrons over time, specially at high temperature. This temperature dependant effect is called « thermal noise ». The thermal noise is included in **dark frames** which are exposures taken with the camera shutter on; the offset is also included in.

Hot pixels are individual cells that are particularly sensitive to this thermal noise and tend to saturate quickly during long exposure. Those hot pixels will have to be processed separately (usually replaced by the average of the surrounding pixels).

An interesting property of thermal noise is that it is linear to the exposure time. For exemple, a thermal noise of a 2sec exposure is twice the thermal noise of 1sec exposure. This means that you can extrapolate any shorter thermal noise frame from a master thermal noise frame with long exposure – assuming you have mapped the hot pixel properly.

This is done by doing a median average of a a long exposure dark frame serie (at least 7 frames, if possible more). Most astronomical software require both the biad frame and the dark frame to pre-process your image. The thermal noise is of course embeded in the dark frame.

Be very careful as the thermal noise (thus the dark frame) is very sensitive to temperature. Make sure to use a Dark frame taken with the same temperature as your spectra. If your camera doesn't have a temperature regulation, you should take dark frame close to the time you expose your spectra. Some software can still extrapolate a proper thermal noise map based on the area of your chip with no signal, which is very easy in the case of LISA spectra.

You do not have to rebuild your dark frame every night; ou can create your library of dark frames taken at different temperatures and use it for several months.

Last but not least is the **Pixel Response Non Uniformity** (PRNU) which is often measured by taking an uniform field (flat field) with your camera and telescope in imaging. You could do the same by putting a diffuse paper or even a camera lens in front of your camera. In practice, the spectral flat (see below) will be sufficient.

## 6.2.2 Calibration frames

Calibration frames should be taken at least one per night. You can do one in the evening after having let the spectrograph cool down and one in the morning to ensure calibration didn't change during the night. If you take only one calibration set, it is recommended to do it in the middle of the night. Whatever your process is, use the same one consistantly for all your observing sessions.

Calibration set consists of two calibration series:

A/ **Flat spectra** which is a spectrum a the tungsten lamp in front of the slit or the spectrograph (put a diffuse paper in front of your telescope and a 200W hallogen lamp for exemple). Of course, you can also use the tungsten inside the optional calibration unit. This flat will be mainly used to get high frequencies pixel non uniform response, caused by dust on the CCD front glass for exemple or overall instrumentation vigneting.



Make sure to take a long serie (about 15 exposures) of flat spectra as the processing will divide your spectra by this flat. The signal has to be as high as possible without any saturation.

B/ **Wavelength calibration spectrum** is an emission spectrum from a lamp. We usually use a Neon for such calibration knowing that there are not a lot of blue lines in such lamps. You can also use Argon lamps if you have one of those – they can sometimes be found in home lamp shops. Take three exposures each time to do a median of them and remove any single exposure defect.

Here are some exemple of calibration, including the Neon hich is within the optional calibration unit:

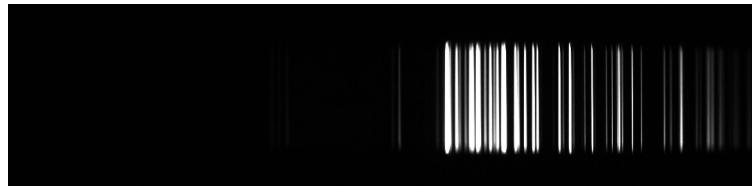

*Neon*

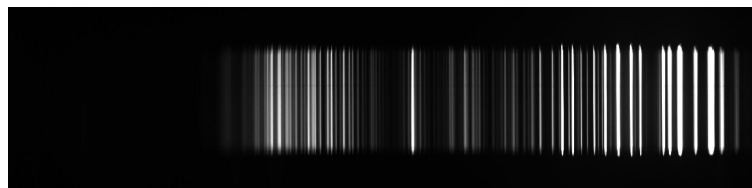

*Decorative lamp (with Argon)*

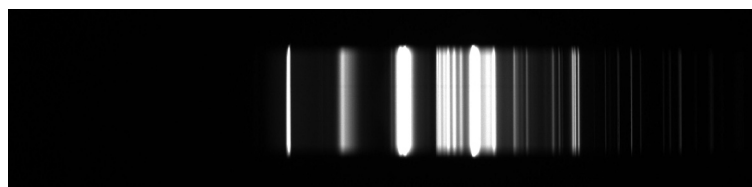

*Energy saving lamp*

### 6.2.3 Object frames

It is recommended to take more than one single exposure to be able to combine your individual exposures into a single one. This will allow to remove for exemple cosmic rays from some exposures. A good combination is the sigma-kapp addition which basically adds all frames pixel by pixel except the one with pixel value « out of the ordinary ». In mathematical terms, we do not include pixel values outside a  $k * \sigma$  of the lot. Some software can do a first pass to remove some pixels really far from the average and a second pass to remove some other ones.

For a sigma-kappa addition to work, you would need several exposures, about 7 to 11 of those.

Of course, you do not want to cut your overall exposure time in too many frames as it not only adds overhead CCD read-out time but also add read-out noise on your final image. In general, it is a good habbit to divide your overall time by about 7 frames and to not have single exposure more than 15minutes. But this is a general rule and you can of course adapt to your own need.

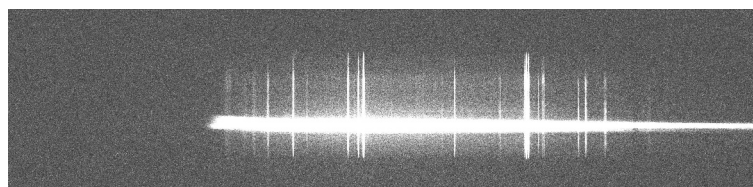

*Exemple of object spectrum (M42 Orion nebula):  
the trail is the star spectrum; the vertical lines are emission from the nebula...*

## **6.2.4 Reference star spectrum**

During the night, take spectra of a reference star. Typically a non variable, non binary, A type star with mainly balmer lines: Vega and Regulus are good choices.

# **7 Processing**

This will detail one way to process your spectra. There are many other paths to come to the same or very similar results.

## **7.1 Preprocessing**

This is a very similar step as for any other CCD imaging. Most astronomical software include some preprocessing functions and can also create your master Bias or Dark frame.

The simplest preprocessing is to subtract from each of your object spectra a dark frame taken with the same exposure time and at the same temperature.

The difference is that you should use a PRNU frame as your flat field or use the high frequency of your Flat (tungsten) spectrum. Simply smooth your Flat spectrum with a gaussian filter and divide your Flat spectrum by this smoothed one to get your high frequency Flat spectrum which can be used as standard CCD imaging Flat field.

## **7.2 Geometry**

Your individual spectra should be corrected from geometrical distortions:

A/ spectrum not fully horizontal (ie: rotation to perform from the center of the image)

B/ spectral lines not vertical (ie: slant or tilt to correct on your spectrum)

C/ spectral lines not straight lines (ie: « smile » effect to correct on your spectrum)

If you properly align your camera, step A/ may not be required. Also, as spectral line from LISA are fairly straight, it is usually not required to do step B/ or C/.

If you apply any geometrical change, make sure to apply the exact same geometrical correction to your calibration frames as well!

## **7.3 Remove background**

Before extracting your spectra, it is critical to remove any background spectra.

Because LISA is a long imaging slit spectrograph, it usually capture your star spectrum but also any other light coming through the slit: human light pollution, earth atmosphere emission lines (such as OI lines which create very nice aurora)...

Those pollution are easy to remove by subtracting the background above and below your spectrum.

## **7.4 Combining spectra**

You can combine your 2D images using an addition or better a sigma-kappa addition. It is also possible to first extract the spectral profile of each individual spectra and combine the profiles. Choice is yours and you can check the difference between the two. Somehow, we have found the on very faint and noisy spectra combining the 2D image was best but in most of the case, combining the profiles were more efficient in the case of LISA spectra.

## **7.5 Extracting spectra**

The easiest extraction is to take the lines with the highest signals and to sum column per column the

pixel values.

The optimal extraction method consists to assign to each pixel, when the summation takes place, a weighting factor proportional to the amount of the signal in it. See papers:

- J. C. Robertson, PASP, 98, 1220-1231, November 1986 (coded and adapted in the command L\_OPTBIN in IRIS software)
- K. Horne, PASP, 98, 609-617 - June 1986 (coded and adapted in the command L\_OPTBIN2 in IRIS software)

From IRIS documentation:

*The Robertson's algorithm (L\_OPTBIN command) is applicable only when the detector columns are perfectly aligned perpendicular to the dispersion direction. If it is not the case at the acquisition time, a post-operation consist for example to apply the TILT command. Although L\_OPTBIN is still useful because it is robust and fast method, and yields good results if such a small misalignment is present.*

*The Horne's algorithm (L\_OPTBIN2 command) is very time consuming (fit of many low-order polynomials along the spectrum). It work for tilted or distorted spectra. But, attention, this algorithm cannot be used if variation in the fraction of starlight falling onto pixels have a more complex form than can be fitted with low-order polynomials. So generally, we prefer use the Robertson algorithm and manual geometric correction of the spectrum (command SLANT, TILT, SMILE, ...).*

*For this two commands it is necessary to give estimation of the mean sky level in ADU (Analog Digital Unit, or Counts). But, very important, before application of L\_OPTBIN or L\_OPTBIN2, the sky is removed of the processed image (use L\_SKY, L\_SKY2, L\_SKY3). The following parameters are the electronic gain of the camera in electrons/ADU and the readout noise (RON) of the CCD camera in electrons. A final parameter ( $\kappa$ ), is a coefficient for adjust cosmic (or hot spot) rejection process (similar to the  $\kappa$  parameter in the  $\kappa$ -sigma rejection method (or sigma clipping) for staking images - see COMPOSIT or COMPOSIT2 commands).*

## **7.6 Wavelength calibration**

Extract your Neon calibration spectrum exactly the same way you have extracted your object spectrum specially in terms of geometrical correction and spectrum extraction area.

Use this Neon spectrum profile to calibrate your object & reference star spectra by using a non-linear wavelength polynomial law.

## **7.7 Instrumental response**

Divide your reference star spectrum by a spectrum - from a catalog - of a star of same spectral class & type. Smooth the division to remove all local spikes due to absorption lines & atmospheric lines. The result is your instrumental response which you can save and archive. It is not mandatory to make an instrumental response every night but worthwhile to check it's still valid from time to time.

Divide all your extracted & wavelength calibrated spectra by this instrumental response to get your final spectral profile, ready to be shared with others and/or to be analyzed.

## **7.8 Software**

RL hires is a free software written by Christian Bui to process L hires III spectra. It can actually also be used to process LISA spectra. Refer to the on-line tutorial for further information. RL hires does perform all operations described above in a single package.



There are several softwares that exist which can be used to do preprocessing and basic geometry correction. IRIS is a free software written by Christian Buil that includes lot of spectroscopy specific functions. Its limitation is around unsigned 16bits files as IRIS works with signed 16bits files.

AudeLA is a powerful open source (ie: free) package that includes telescope control and autoguiding (on a star but also on a slit), and all functions to process your spectra.

RSpec is a spectroscopy dedicated software which is limited in terms of fonctionnality but works real time, making spectroscopy very fun. It is a great software for educational purposes or to discover spectroscopy.

VisualSpec is a free software dedicated to spectroscopy. It doesn't preprocess files (but you can use AudeLA for this) but you can extract profile and wavelength calibrate your spectra. Most importantly, VisualSpec does include a lot of functions to analyse your spectra either manually or through a batch. VisualSpec includes an extensive user documentation which you can easily refere to.

***Note: While several paths can reach the same goal, we recommend you to use the RLhires all-in-one package to extract your spectra and VisualSpec to analyse them.***

IRIS: <http://astrosurf.com/buil/iris/>

RLhires: <http://astrosurf.com/buil/rlhires/tuto1.htm>

VisualSpec: <http://www.astrosurf.com/vdesnoux/>

AudeLA: <http://audela.org/dokuwiki/doku.php?id=fr:start>

SpcAudace (AudeLA module): <http://bmauclaire.free.fr/spcaudace/>

## 8 Spectroscopy: introduction



### 8.1 In the beginning

Spectroscopy really started around 1666 when sir Isaac Newton dispersed sunlight with a prism. But it's in 1802 that William Wollaston discovered "dark" absorption lines, lines studied later by Joseph von Fraunhofer who published a catalog of several hundred of those lines in 1815. We now have classified thousands of absorption lines in the solar spectra.

In 1849, Léon Foucault studied emission lines produced by a Sodium lamp. Gustav Kirchoff and Robert Bunsen identified the same lines in the solar spectra in 1857.

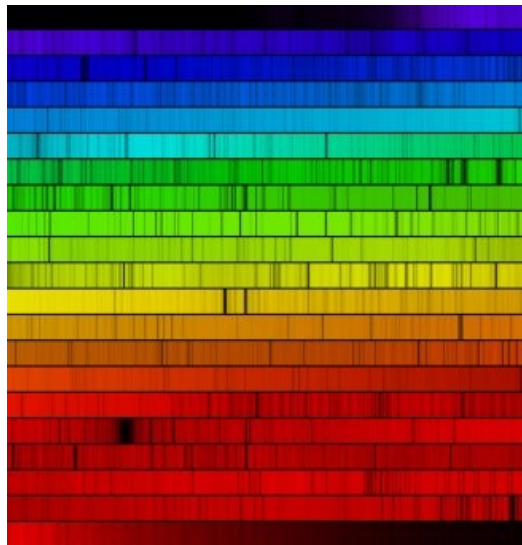

*solar spectra with a Lhires III (O.Garde)*

### 8.2 Different types of spectra

Spectrography analyses light from sources away from us. It allows the study if the chemical composition, temperature, pressure, and movement.

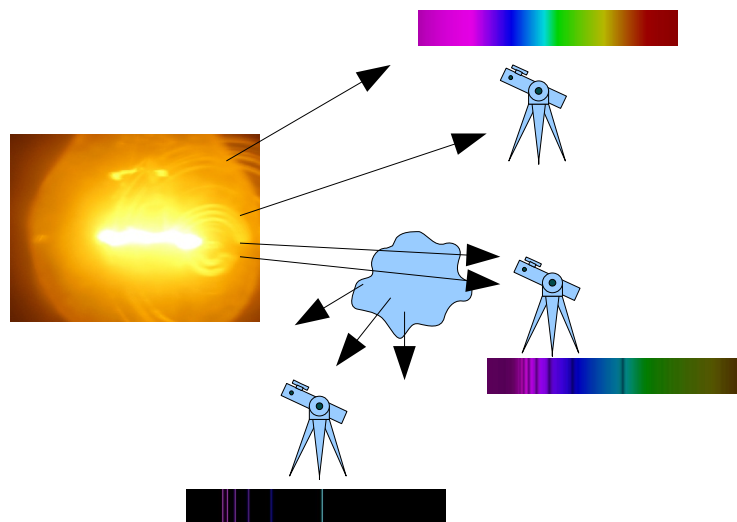

There are three types of spectra, following the Kirchoff law:

1. Continuous spectra: it is emitted by any solid or gaseous body under high pressure and high temperature. Stars are, under first approximation, like black body whose continuous spectra has a shape which depends on its surface temperature.



2. Absorption line spectra: a low pressure low temperature gas crossed by a continuous light absorbs some photons. Spectra then shows dark lines in front of the continuous spectra.



3. Emission line spectra: a low pressure high temperature gas emits a light made of few radiations, characteristics of the atoms that constitutes this gas. Each chemical element has its own line spectra, true identity card of its composition and state.



An important property of those absorption and emission spectra is that lines are emitted at the same wavelength that they are absorbed.

### **8.3 Message from light**

Spectroscopy was extended to the study of stars and nebulae in which new elements were discovered. Sir Norman Lockyer and Jule Janssen discovered in 1868, during a solar eclipse, a new element which has been isolated on Earth in 1895: Helium.

Johann Balmer developed an empiric formula in 1885 for the position of hydrogen emission line (H $\alpha$ , H $\beta$ , H $\gamma$ ...). This formula was extended to other elements by Johannes Rydberg. But it's Niels Bohr who brought in 1920 a theory to the spectral line process. The Bohr model is based on quantum theory and electronic clouds around atomic nucleus.

Astronomy faced a revolution, an evolution toward Astrophysics. The language of light was just decrypted!

Coded light is rich of information:

- on effective temperature at the surface (Wien law)
- on radial, rotation and expansion movement (Doppler effect)
- on stellar density and pressure
- on chemical composition

## 8.4 Effective temperature and spectral types

Stars are almost like black bodies. They emit energy at all wavelengths with a continuous spectra. Its shape is a Planck curve whose maximum is directly linked to the effective temperature of the surface (stellar atmosphere); this is the Wien law.

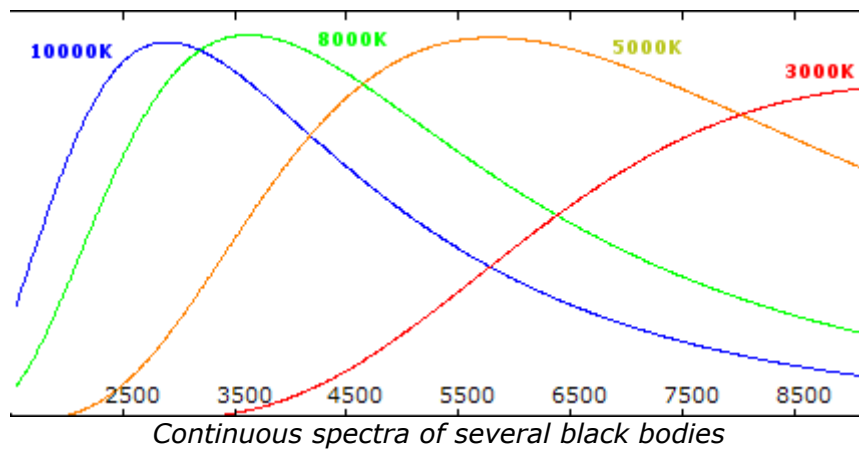

Our Sun has an effective surface temperature around 6000K; visible stars to us have temperature between 3000K and 30000K.

Stars are classified based on their temperature with historical letters O, B, A, F, G, K, M. Stars with O type are the hottest while M type are the coolest. We memorize this sequence with the famous "Oh Be A Fine Girl (Guy), Kiss Me". Types R, S, and N have been added later one ("Right Now Sweetheart!").

Annie Jump Cannon was one of the most famous assistant of Edward Charles Pickering in Harvard. She was an expert in stellar classification. For the Henry Drapper catalog, she classified more than 300000 stars, an example of productivity!

## 8.5 Spectral class

If the spectral type is a characteristic of the surface temperature, a more precise classification should take into account their luminosity. In Yerkes, William Morgan, Philip Keenan, and Edith Kellman (MMK) established a classification I to V which takes into account the shape of some absorption lines, characteristics of gravity forces. Class I stars are super giants while class V (like the Sun) are sub giants stars.

Astrophysicists position stars on a graph based on their temperature and luminosity. This is the Hertzsprung-Russell diagram.

## 8.6 Chemical composition and metallicity

Two stars of same class and same type have a different history, a different genealogy. We note Z the metallicity or the ratio of atom different than hydrogen and helium. One can position each star on a 3 dimension HR-Z diagram: temperature, luminosity, and metallicity.

We classify stars in two populations:

1. Population I: stars rich in metal (ie: non hydrogen or helium atoms), often second or third generation stars. Part of their matter has been created during the explosion of a supernova. Our Sun and matter that constitutes us is a good example.
2. Population II: stars poor in metal, very old. We can find them typically in globular clusters.

## 8.7 Doppler Effect

Doppler effect, explained by Christian Doppler in 1842, is a wavelength shift between emitted light and received light when object and observer are moving from each other. If they approach themselves, shift is toward blue; if they are moving away, it is toward the red (such as the "redshift" of galaxies).

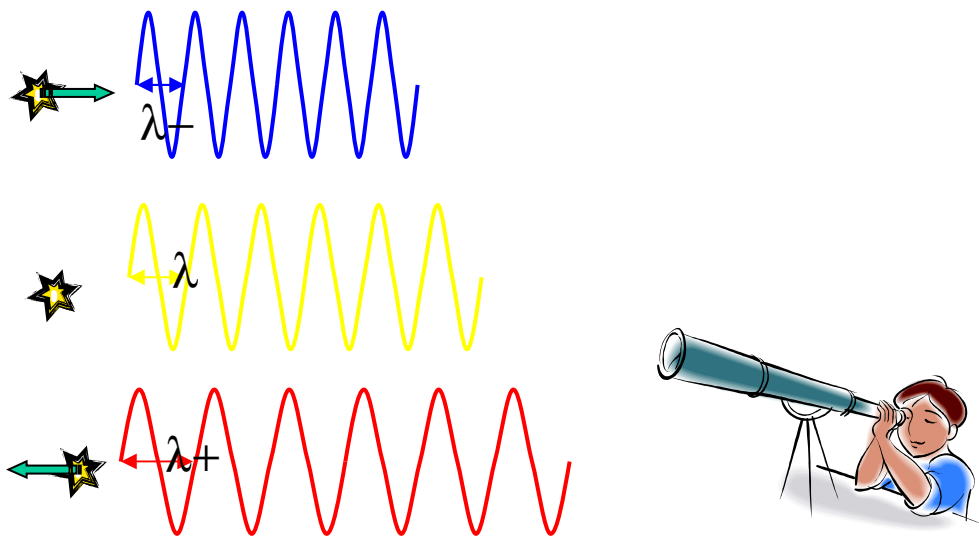

Doppler effect allows to measure radial velocity, rotational speed, and expansion speed. It is the key to study binary systems and it has been the key of the discovery of the first exoplanet in 1995.

Line profiles are also modified by wave movement at the surface of stars. Asterosismology allow to better understand the internal structure of stars. Even if one can't see the star surface visually, their light brings us a message full of learning!

## 8.8 Conclusion

Spectrography is like archeology or a criminal case study. With clues included in spectra, the astrophysist tries to go back to the root of the phenomena. Almost all professional observations are done today in spectrography. Large telescope are equiped with powerful spectrographs to analyse large spectral domain and several targets at once. But now spectrography is evolving within the amateur astronomy community. High resolution spectrography - the message from the stars - is now accessible to you with your Lhires III.

## 9 Troubleshooting / Support

For any issue with your Lhires III, contact us at:

Phone: +33.476.41.36.81

Mobile: +33.689.92.74.23

eMail: [contact@shelyak.com](mailto:contact@shelyak.com)

Web: <http://www.shelyak.com>

Address: Les Roussets

38420 Revel

France

You can also subscribe to the Spectro-L internet list where you will find the support of other Lhires III users: <http://groups.yahoo.com/group/spectro-l/>

And regularly look on our website for project update and announcement of technical week-ends; those are the best way to learn and develop yourself in this wide field that is spectrography!

## 10 References

This is only a few of references that we find useful. If you know others, do not hesitate to drop us a note ([contact@shelyak.com](mailto:contact@shelyak.com)) so it can be added in further release of this user guide.

### 10.1 Books

**Note: see our web site for a more complete list of bibliography:**  
[http://www.shelyak.com/dossier.php?id\\_dossier=35&lang=2](http://www.shelyak.com/dossier.php?id_dossier=35&lang=2)

First, check the link: <http://www.ursusmajor.ch/astrospektroskopie/richard-walkers-page/index.html>

Scroll down the web page to get the english version of Richard Walkers \*free\* book on spectroscopy. An excellent first-read!

Here is a list of several book which are related to Spectroscopy. Some of them are "must have" in your private library!

#### Historical Books

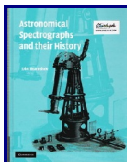

#### ***Astronomical spectrographs history***

*John B. Hearnshaw; ed. Cambridge*

While the book is thin and expensive, it is a must have for those interested in spectrograph's history. Very well documented.

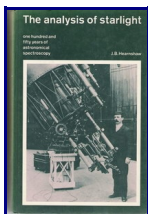

#### ***The analysis of starlight***

*John B. Hearnshaw; ed. Cambridge*

Out of print book. A reference for anyone interested in spectroscopy in general and history in particular. State of the art book with detailed reference's list. A must have!



#### ***Spectroscopic astrophysics - contribution of Otto Struve***

*Georges H. Herbig*

Very interesting compilation of article to get an overview of astrophysics in early twentieth century. Articles can also be found on Abstract Data Services but they are all followed by an update of the knowledge in the

1960's.

## Spectroscopy books

### ***Stars and their Spectra, an introduction to the spectral sequence***

*James B. Kaler*

While this book is getting old and some would prefer "Spectral Classification" from Richard Gray, James Kaler book on spectral classification is of easier access for amateurs. One of the top book to have in your personal library.

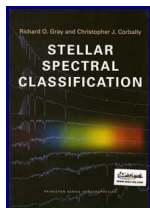

### ***Spectral Classification***

*Richard O. Gray & Christopher J. Corbally (2009)*

A recent and complete book on spectral classification. It supersedes somehow Jaschek & Jaschek book on the same subject. One of the top book to have in your personal library.

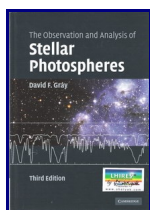

### ***Observation and analysis of Stellar Photospheres***

*David F. Gray*

One of the top book to have in your personal library. Graduate level with lot of figures/spectra and examples.

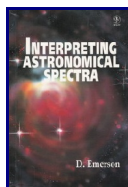

### ***Interpreting Astronomical Spectra***

*D. Emerson*

While a little bit old, this book contains some very interesting references. Superseded by David Gray's "stellar photosphere" book.

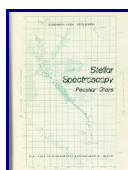

### ***Stellar Spectroscopy - Peculiar Stars***

*Hack & Struve*

Small but very interesting book with examples and ideas for your own spectrograph to work on. Second part.

### ***Stellar Spectroscopy - Normal Stars***

*Hack & Struve*

Small but very interesting book with examples and ideas for your own spectrograph to work on. First part.



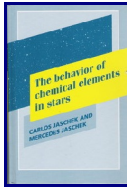

### ***The behavior of chemical elements in Stars***

*Carlos Jaschek & Mercedes Jaschek*

This books lists, per element, which star you can see those element on.  
Work in pair with "The Classification of Stars"



### ***The Classification of Stars***

*Carlos Jaschek & Mercedes Jaschek*

This book lists, per spectral type, which spectral line element to look for.  
Work in pair with "The behavior of chemical elements in Stars". Some may  
prefere a more recent book: "Spectral Classification" from Richard Gray

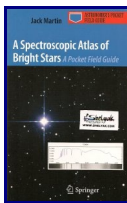

### ***Spectroscopic atlas of bright stars***

*Jack Martin*

Part of Springer serie on Astrophysics. Made with a low resolution grating,  
several spectra of bright stars to compare.

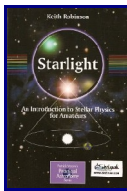

### ***Starlight***

*Keith Robinson*

Part of Springer serie on Astrophysics.

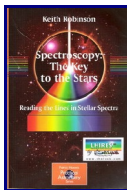

### ***Spectroscopy key to the stars***

*Keith Robinson*

Part of Springer serie on Astrophysics.

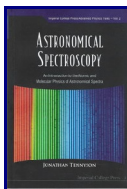

### ***Astronomical Spectroscopy***

*Jonathan Tennyson*

Professional book usefull for spectrograph builders, sometimes complex for  
amateurs.

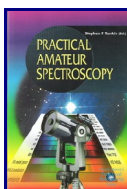

## **Practical Amateur Spectroscopy**

Stephen F. Tonkin with several authors

Part of Springer serie on Astrophysics. One of the first of the serie, published when very few commercial spectrographs were available so a large part is dedicated to home made instruments.

## **Astrophysics books**

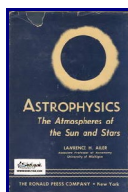

### **Astrophysics - atmospheres of the Sun and Stars**

Lawrence H. Aller; ed. The Ronald Press Company

A little bit old book now.

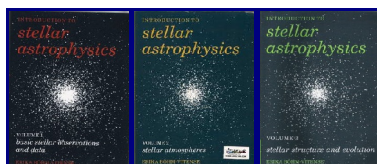

### **Introduction to Stellar Astrophysics T1-3**

Erika Bohm-Vitense

A three book course on stellar astrophysics.

Tome 1: basic stellar observations and data.

Tome 2: stellar atmosphere.

Tome 3: stellar structure and evolution.

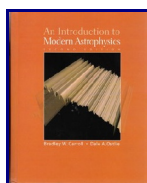

### **Introduction to modern Astrophysics**

Bradley W. Carroll & Dale A. Ostlie

A thick but excellent reference book. Almost every aspects of astrophysics are covered and the book includes tons of exercises (unfortunately, without answers!). A must-have in your library!

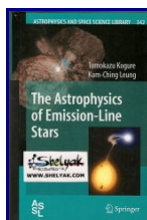

### **Astrophysics of emission-line stars**

Kogure & Leung; ed. Springer (2009)

A new and very detailed book on all emission line stars (Wolf-Rayet, Be, T Tauri...). Includes several tables with key targets for our spectrographs.

An excellent book.

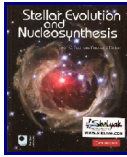

### ***Stellar evolution and nucleosynthesis***

Sean G. Ryan, Andrew J. Norton; ed. Cambridge

Graduate level book but an excellent course support which includes exercises \*and\* solutions!

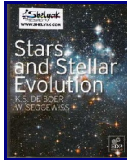

### ***Stars and stellar evolution***

K.S. de Boer & W. Seggewiss; ed. EDP

Overview of the subject. Interesting mainly as first book on stellar astrophysics.

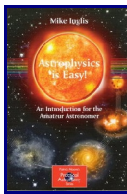

### ***Astrophysics is easy, an introduction for the amateur astronomer***

Mike Inglis

Part of Springer serie on Astrophysics. This book lack of practical (very hard to find a spectrum in the book) but the explanations are crystal clear and this by itself makes this book valuable.

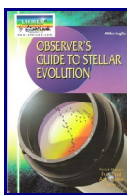

### ***Observer's guide to Stellar Evolution***

Mike Inglis

Part of Springer serie on Astrophysics. Like most books of the serie, the subject is briefly reviewed but in a simple manner which several shall like.



### ***Introduction to the study of stellar structure***

S. Chandrasekhar

An interesting book to take into the historical context of that time.



### ***Stellar atmospheres***

Mihalas

Old book but still a reference to place into the context of his time.



### **Theory of stellar pulsation**

John P. Cox; ed. Princeton University Press

This book has been a key reference at that time. A little bit old now.

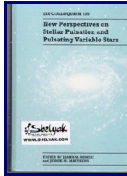

### **New perspectives on stellar pulsation and pulsating variable stars (IAU139)**

James M. Nemec & Jaymie M. Matthews

Graduate level compilation of article from International Astronomical Union colloquium #139. Some would prefer more recent work such as Thompson's "Asteroseismology across the HR diagram". Articles can also be found on Abstract Data Services.

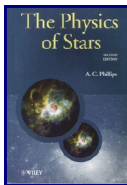

### **The Physics of Stars**

A.C. Phillips; ed. Wiley

Graduate level book.

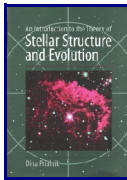

### **An introduction to the theory of Stellar Structure and Evolution**

Dina Prialnik

Graduate level book with an interesting high level first chapter. Includes also the maths for spectroscopic binaries study.

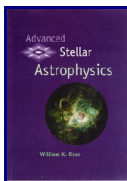

### **Advanced stellar astrophysics**

William K. Rose

Graduate level book.

### **Foundations of Astronomy**

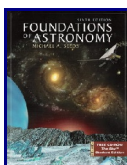

Michael S. Seeds

Encyclopedia type book, covers in general all subjects including astrophysics.

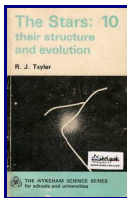

## ***The stars - their structure and evolution***

*R. J. Tayler; ed. The Wykeham Science Series for schoold and universities*

Almost an historical book to place into context.

### **NASA/CNRS monographs (by spectral types)**

In 1980's, NASA & CNRS published a monograph series on nonthermal phenomena in stellar atmospheres. Those make an excellent overview of the science knowledge of the stars at that time. Introduction is translated in french.



## ***O stars and Wolf-Rayet stars***

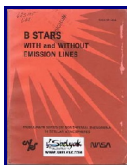

## ***B stars with and without emission lines***

*NASA SP-456; Anne B. Underhill*

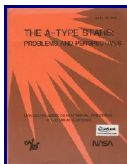

## ***A-type stars***

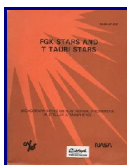

## ***FGK stars and T Tauri stars***

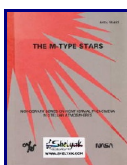

## ***M-type stars***

*NASA SP-492; Johnson*

## Early-Type stars books

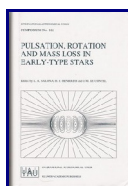

### ***Pulsation Rotation and Mass Loss in Early-type Stars***

*Balona, Henrichs, Lecontel*

Graduate level, compilation of articles of the International Astronomical Union Symposium #162. Articles can also be found on Abstract Data Services.

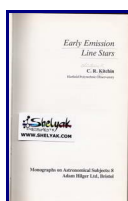

### **Early emission line stars**

*C.R. Kitchin; ed. Adam Hilger Ltd, Bristol*

Book to place into context, for collectors.



### **Stars with the B[e] phenomenon**

*Michaela Kraus & Anatoly S. Miroshnichenko*

Graduate level but with excellent general overview of B[e] in first articles. Articles can also be found on Abstract Data Services.

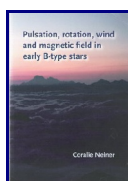

### **Pulsation, rotation, wind and magnetic field in early B-type stars**

*Coralie Neiner*

Thesis on the subject, graduate level. Articles can also be found on Abstract Data Services.

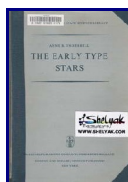

### **The early type stars**

*Anne B. Underhill*

Book to place into context, for collectors.

## Variables stars books

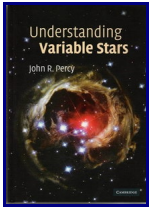

### **Understanding variable stars**

John Percy; ed. Cambridge (2008)

John Percy wrote several articles in Sky & Telescope. This book is an excellent recent overview of variable stars with key tables listing targets for your spectrograph. A top book to own in your personal library.

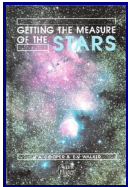

### **Getting the measure of the stars**

W.A. Cooper & E.N. Walker

The book is focused on photometry as amateurs were doing very few spectroscopy at that time. The book goes through the HR diagram and highlights where amateurs can contribute - still the case today.



### **Variable stars observers handbook**

John Glasby

Old book, mainly for historical purpose.

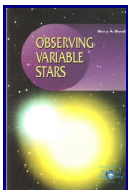

### **Observing Variable Stars**

Gary A. Good; ed. Springer

## Gaz & Nebulae books

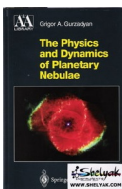

### **Physics and dynamics of planetary nebulae**

Grigor A. Gurzadyan

Obviously translated, this is a graduate level book.

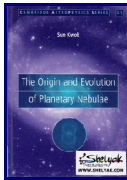

**Origin and evolution of planetary nebulae**  
*Sun Kwok; ed. Cambridge Astrophysics Series*  
 A reference book on the subject; graduate level.

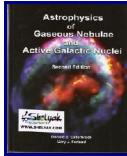

**Astrophysics of gaseous nebulae and AGN**  
*Donald E. Osterbrock & Gary J. Ferland*  
 Graduate level book.

### Specific subjects books

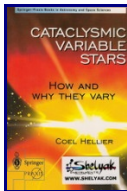

**Cataclysmic Variable Stars**  
*Coel Hellier*  
 Excellent book on this subject, including list of variables to take with your own spectrograph.



**Non stable stars (1957)**  
*Georges H. Herbig*

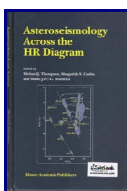

**Asteroseismology across the HR diagram**  
*Michael J. Thompson*  
 Very interesting article compilation on this subject; graduate level. Articles can also be found on Abstract Data Services.

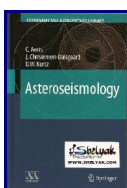

**Asteroseismology**  
*Conny Aerts, Jorgen Christensen-Dalsgaard, Donald W. Kurtz; ed. Springer*  
 Written by professional experts in this field, this recent book is a graduate level but include some excellent and understandable parts, including a great introduction to the subject.



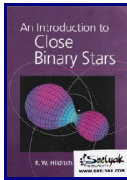

***Introduction to close binary***  
*R.W. Hilditch*

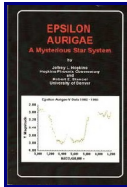

***Epsilon Aurigae, a mysterious star system***

*Jeffrey L. Hopkins & Robert E. Stencel (2009)*

Written before the 2009/2010 eclipse, this book covers the knowledge on this very interesting system (27y periodic variable!).

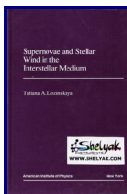

***Supernovae and stellar wind in interstellar medium***

*Tatiana A. Lozinskaya*



***RR Lyrae***

*Horace A. Smith; ed. Cambridge Astrophysics Series #27*

A little bit disappointing and graduate level book on RR Lyrae stars.

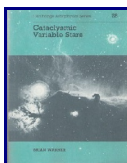

***Cataclysmic Variables Stars***

*Brian Warner; ed. Cambridge Astrophysics Series #28*

Excellent but graduate level book on the subject.

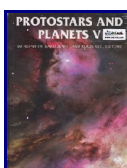

***Protostars and planets V***

*Bo Reipurth, David Jewitt & Klaus Keil*

Articles can also be found on Abstract Data Services.



### **Tenth anniversary of 51 Peg-b**

Luc Arnold, François Bouchy & Claire Moutou; ed. Observatoire de Haute Provence, Frontier Group (2005)

Une bonne revue des connaissances et des questionnements dix ans après la découverte de la première exoplanète 51 Peg-b.

## **Books on Physics**

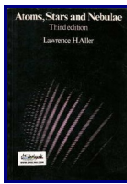

### **Atoms Stars and Nebulae**

Lawrence H. Aller

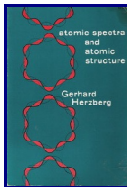

### **Atomic spectra and atomic structure**

Gerhard Herzberg

Excellent book on how it works at atomic level.

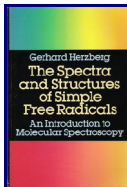

### **The spectra and structures of simple free radicals, an introduction to molecular spectroscopy**

Gerhard Herzberg

This book is the follow up of "Atomic spectra and atomic structure" and covers a more complex subject: how spectroscopic lines are formed in molecular structures.

## **Miscellaneous books**

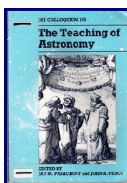

### **Teaching of Astronomy**

IAU Colloquium 105

Cover most aspect of education and teaching in astronomy.



### **Extreme Stars**

*James B. Kaler; ed. Cambridge*

James Kaler writing makes it a general public book. The largest star, the brightest star, the most massive star...

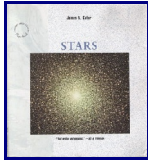

### **Stars**

*James B. Kaler*

James Kaler writing makes it a general public book. Overview of stars.



### **The hundred greatest stars**

*James B. Kaler*

James Kaler writing makes it a general public book. He is highlighting 100 stars which are all of some interest.

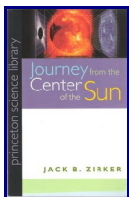

### **Journey from the center of the Sun**

*Jack B. Zirker; ed. Princeton Science Library*

Excellent book covering our knowledge of our star but also all the mysteries still to resolve - and there are a lot!

## **Technology books**

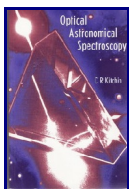

### **Optical Astronomical Spectroscopy**

*C.R. Kitchin*

One of the reference book for spectrograph builders.

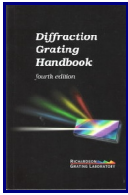

## **Diffraction Grating Handbook**

*Richardson Grating Laboratory*

Some interesting information in this free book; useful for instrument builders.

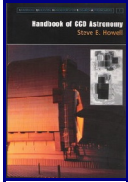

## **Handbook of CCD Astronomy**

*Steve B. Howell*

An excellent but serious book on CCD technology. Everything about signal/noise!

## 10.2 Web links

### 10.2.1 General

**Shelyak Instruments:** <http://www.shelyak.com>

This is our web site where you can find additional information on your LISA spectrograph, more ideas for projects, etc...

**ARAS home page:** <http://www.astrosurf.com/aras/>

ARAS is an amateur/professional group with objective to promote spectrography.

**Spectro-L list:** <http://groups.yahoo.com/group/spectro-l/>

**Christian Buil** web site: <http://www.astrosurf.org/buil/>

Christian's **Spectro bookmark:** <http://astrosurf.com/buil/us/book2.htm>

**CDS Strasbourg:** <http://http://cdsweb.u-strasbg.fr/>

This is THE reference for any astronomical object. Look for key information, browse through hundreds of catalogs, and link to professional work done on any specific object.

**ADS:** [http://adsabs.harvard.edu/abstract\\_service.html](http://adsabs.harvard.edu/abstract_service.html)

This is THE reference where to find for professional articles. Thousands articles are scanned and available to the amateur community through that link.

### 10.2.2 Software

**Iris:** <http://www.astrosurf.org/buil/us/iris/iris.htm>

**RL hires:** <http://astrosurf.com/buil/rlhires/tuto1.htm>

**VisualSpec:** <http://astrosurf.com/vdesnoux/>

**Audela:** <http://audela.org/dokuwiki/doku.php?id=fr:start>

**SpcAudace:** <http://bmauclaire.free.fr/spcaudace/>

# 11 Appendix

## 11.1 Appendix A - Add Automatic Calibration Module

Calibrating precisely the spectrum is key to use it for scientific application. An optional calibration module can be added on the LISA, to remotely control the instrument. This calibration module contains both halogen (for flats) and neon (for wavelength calibration) lamps. Here is how to proceed to install it.

- Remove the screw on LISA side (same side as the calibration window).



- Remove the calibration window cover

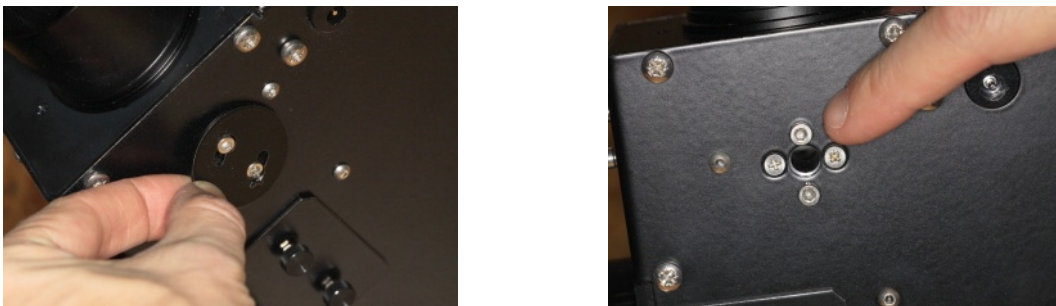

- Take the calibration module, and insert the plug into the LISA connector (for calibration screen activation)



- Adjust the calibration module onto the LISA side



- Tighten the screw



You can test the module is properly working. Connect a 12V power supply in one of the calibration module connector. Switch on & off the matching button (ie flat or neon). You must hear the electro-magnet activation, and see the light in the spectro (the flat light is easy to see, the neon one is fainter).



If you want to use the calibration light remotely, connect a controlled 12V power supply in each connector of the calibration module, and switch the buttons on.



If, for any reason, you decide not to use the calibration module anymore, don't forget to put back the calibration window cover and the M4 screw – to prevent any light leakage into the spectrograph.



## 11.2 Appendix B - Opening / closing the LISA

In some specific conditions, you can have to open the LISA. This operation must be done only if you exactly know what you're doing. After such an operation, you could have to check the tuning is still Ok, and probably to refine the tuning.

The LISA is made of two major assemblies : The chassis, and the cover. The chassis embeds all optical elements of the spectrograph (slit, main mirror, collimator, grating, camera lense). This is done to make possible to tune the instrument when it is opened. The covers contains all elements for guiding and calibration.

You can see that Chassis and Cover don't have the same height : the splitting line is not in the middle of the instrument.

Remember that the Chassis is the thinnest part, and the Cover the thickest.

### LISA – function of main screws

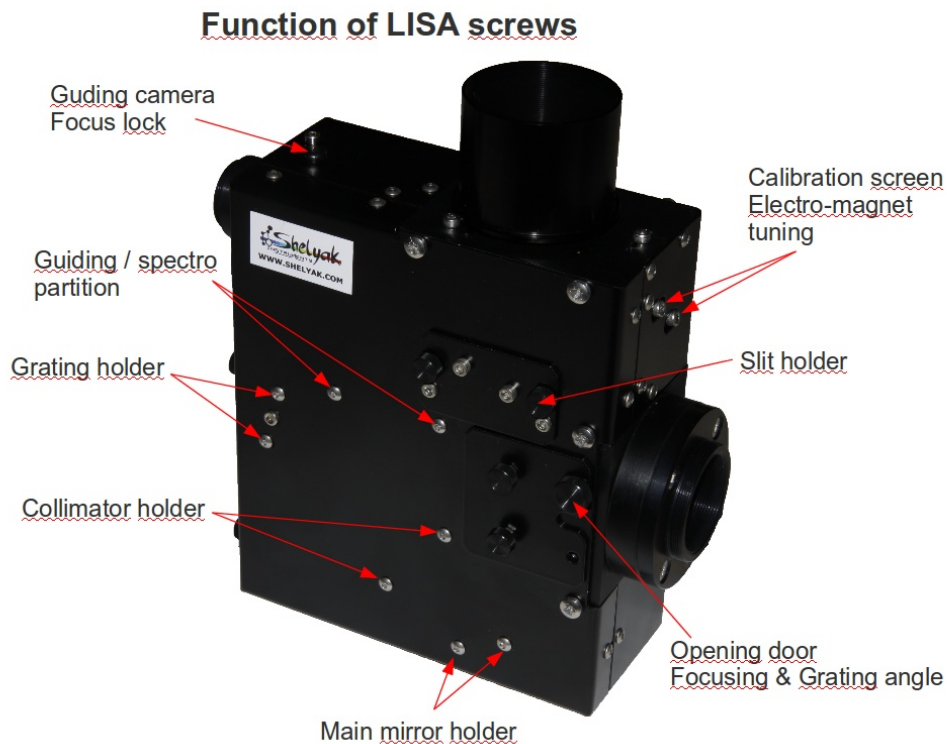

### OPENING

Both parts can be separated. To do so, follow strictly these instructions :

- Remove the LISA from the Telescope



- Remove CCD camera and guiding camera.
- Remove 2 screws (M3x10mm) from the the Chassis side



- Remove 2 screws (M4x10mm) from the Telescope plate side (Chassis side)



- Remove 2 screws (M4x10mm) from the CCD camera plate side (Cover side)



- Untighten 9 screws (M3x10mm) all around the spectrograph, on the Chassis. These screw must be left in place - no need to remove them completely.

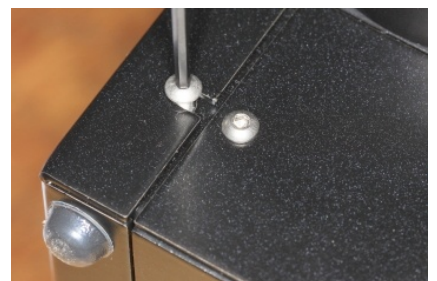

- Remove the two side doors (remove one big screw for each, and slide the doors towards the CCD camera)



- Remove the plastic screw (main lense lock)



- Catch the instrument like on the picture : put one thumb in each door opening, CCD camera holder towards yourself.



- Slightly open the instrument, keeping both sides parrallels. This can be quite difficult the first time : do it very carefully. If necessary, use a small tool (like a screwdriver) to start the opening (you can slide it between two sides). Take care to not damage the painting.
- The LISA is now open. Be very careful with the optical elements : they are very fragile. Think to protect them against dust and finger prints !

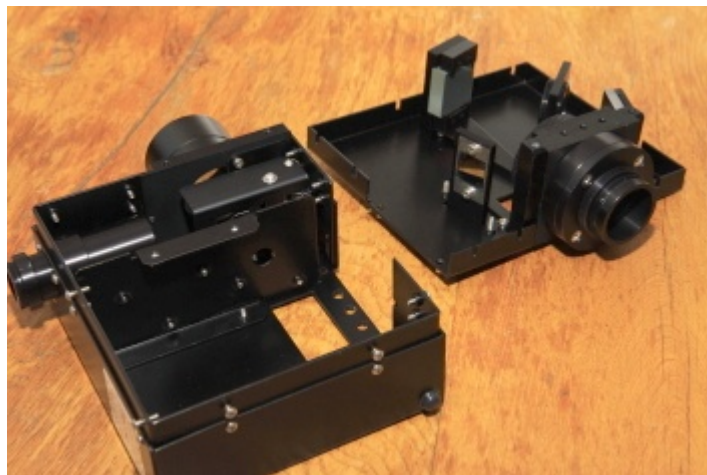

## CLOSING

Of course, closing the LISA is exactly the same operation, in the opposite order.

- Take the Chassis in left hand and the Cover in right hand. Catch them by putting the thumb in door opening



- Present them with precision, well parallelly fitting. Engage the Telescope plate and the CCD plate first (check they are exactly at the right position)

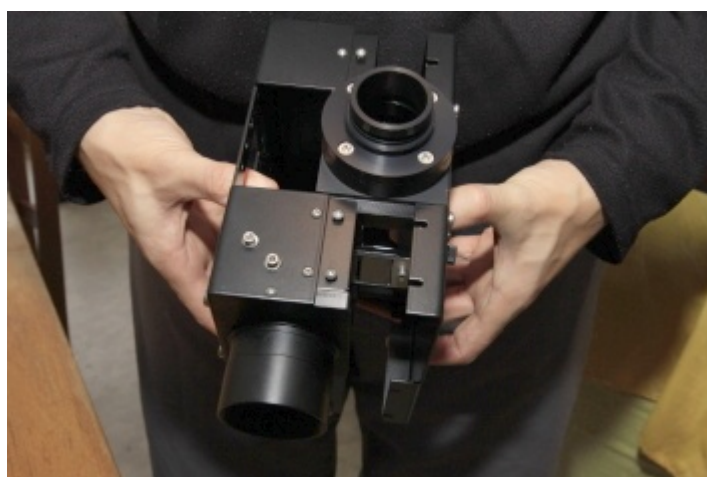

- Slide both sides together, until the box is closed. Check all area is properly positionned, all

around the spectrograph.



- Put the plastic screw (main lense lock)



- Put 2 screws (M4x10mm) on the CCD plate side



- Put 2 screws (M4x10mm) on the telescope plate side



- Put 2 screws (M3x10mm) on the LISA side



- Tighten all these 6 screws
- At the end, tighten all nine screws around the spectrograph



- Finally, close the side doors



- Your LISA is back ready for observation. Depending on what you changed when you opened the instrument, you may have to re-tune some parts of the instrument.

### **11.3 Appendix C - Switching from VIS to IR**

The LISA can be configured in two modes : Visible and Infra-red. The standard configuration is Visible. You can switch IR configuration, using the IR conversion kit, provided as an option by Shelyak Instruments.

There are three differences between VIS and IR configurations :

- The grating is different (VIS is blazed at 500 nm, IR is blazed at 1000nm)
- There is a blocking filter after the slit in the IR configuration, to prevent any second order spectrum mixed with the IR part of the first order
- The CCD camera spacer makes an angle of 4° with the spectrograph face, to ensure a good focus on a large spectra range.



To switch from VIS to IR configuration, follow these instructions :

### A – Changing the grating

- Open the LISA (see appendix B)
- Untighten the two external screws of the grating holder in LISA. Keep in place the central screw : it is used as a simple rotating axis.



- Maintain securely the grating holder when removing it. Take care to never put the finger on the grating surface – it would be definitely destroyed.



- Remove the grating lever from the holder (2 screws)

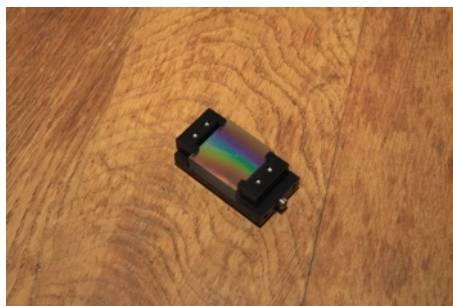
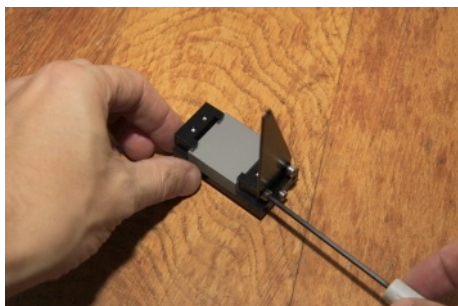

- Take the IR grating from the conversion kit. Remove carefully the protection cover, by untightening the screw

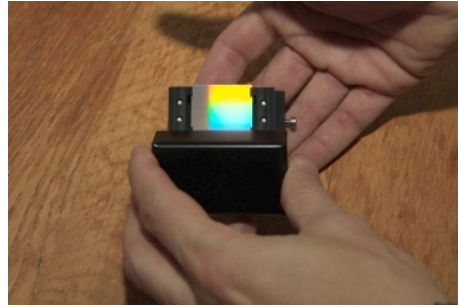
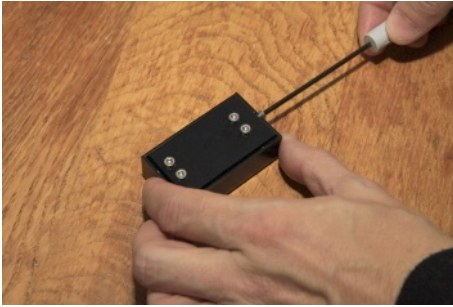

- Put the cover on the VIS grating holder (tighten the screw)
- Put the lever on the IR grating (2 screws). Respect the direction of the lever, like on the picture :

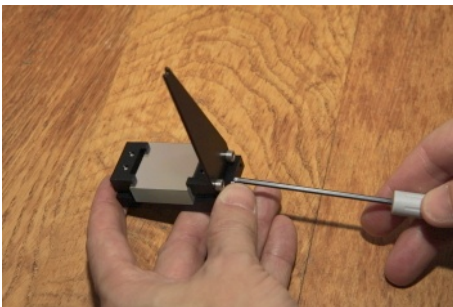

- Put the IR grating in place, onto the chassis.
- Put the lever at the approximate position given on the picture :



- Close the LISA (see appendix B)
- Put the VIS grating holder in a safe place

**B – Installing the blocking filter**

- Remove the slit from the LISA (two screws)



- Install the blocking filter on the opposite side of the slit. Take care to not damage the slit by itself : don't put it on the table, keep the part in hand !

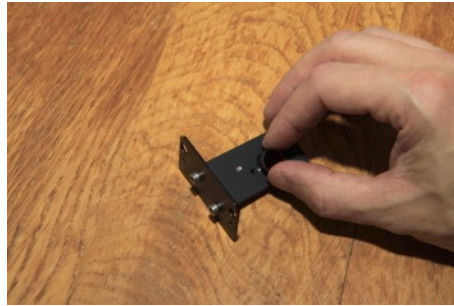

- Put 2 screws, with plastic rings on each side of the filter. Tighten them slightly : the filter must be fixed, but not damaged.

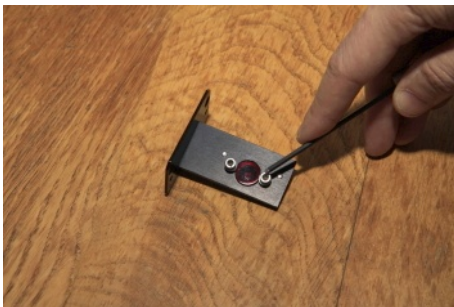

- Reinstall the slit in the LISA.

### C – Changing the CCD camera spacer

- Remove 4 screws from the CCD camera holder. You'll get the CCD camera holder by itself (threaded part) and the spacer

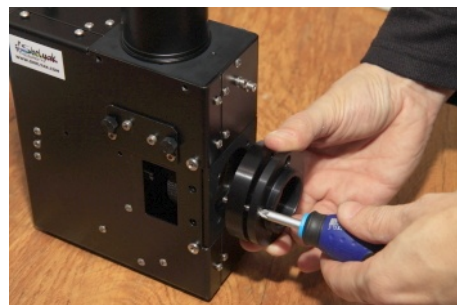
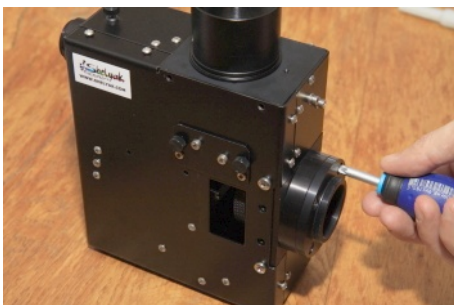

- Install the inclined spacer on the LISA with 4 screws (M4x10mm). The orientation must be as on the picture :



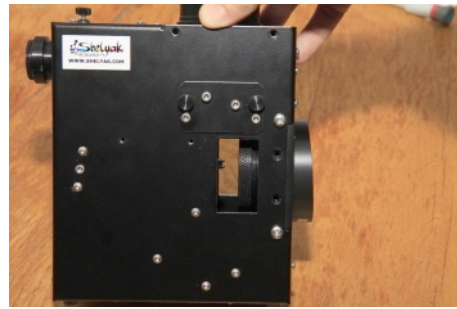
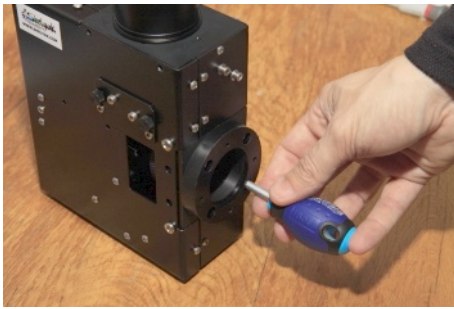

- Install the CCD camera holder with 4 screws (M4x12). There is no specific orientation.



## D – Tuning

Once all above modifications are finished, you must tune the grating angle. This is described in detail in Appendix E

### **11.4 Appendix D - Switching from IR to VIS**

The conversion from IR configuration mode back to VIS mode is obviously the reverse operation of above section. Refer to it for detailed operations. Generally speaking, the operations consist in :

- Open The LISA, and replace IR grating (+holder) by the VIS grating.
- Remove the blocking IR filter (if you forget it, you'll see only the deep red part of the spectrum)
- Remove the inclined CCD camera spacer and replace it with the parallel spacer.

### **11.5 Appendix E - Tuning the grating angle**

The grating angle is key to get the best spectrum quality in LISA. This is a sensitive tuning, which must be done by an experienced user only. To make this tuning, you must put the LISA on a stable surface (large table, for instance), and install the CCD acquisition camera. You must have the full setup operational to take some spectra, using calibration light (neon, energy saving lamp, Hg... if you don't have such lamp, use the solar spectrum – but this is harder to measure lines width).

This tuning is much more easy to do with a tuning slit (provided by Shelyak Instruments) : this is a slit with one hole (19 $\mu$ m) and a partial slit (19 $\mu$ m) on each side. The advantage is that each spectrum line taken with this slit is a point, and it is easy to measure precisely the FWHM, to evaluate the focus range.

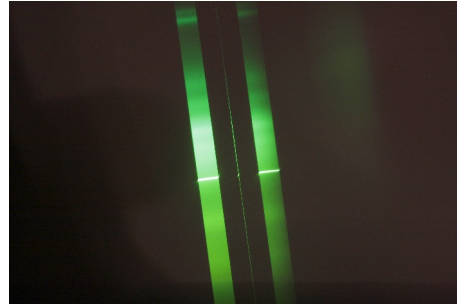

Defining the best grating angle is necessary for

- Getting the expected wavelength bandwidth in the CCD surface
- Getting focused lines in the widest bandwidth

The grating angle is easy to change :

- Remove the side door below the slit

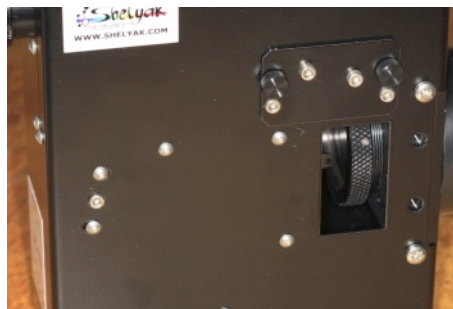

- Untighten the two screws on the grating holder (do not touch to the central screw, it is the rotation axis of the folder). **Caution** : Do not remove the screws : the grating would fall down into the instrument.



- Use the grating lever (in the door opening) to precisely change the grating angle, and tighten back the screws.

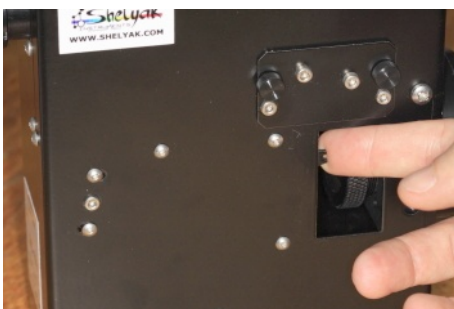

When you change the grating angle, the spectrum will be moved horizontally (along wavelength axis) in the image. Make some tests : move the grating lever by a very small angle, and look at the effect in the image. Train yourself to put a given spectrum line at a given position (pixel X in the image).

The two configurations (VIS and IR) have, of course different grating angles.

### A – Configuration VISIBLE

We suggest to use a Neon spectrum to tune the angle. In this Neon spectrum, locate the « 5 lines pattern » around Ha (6563A), and specially the central line of this group (6598A) :

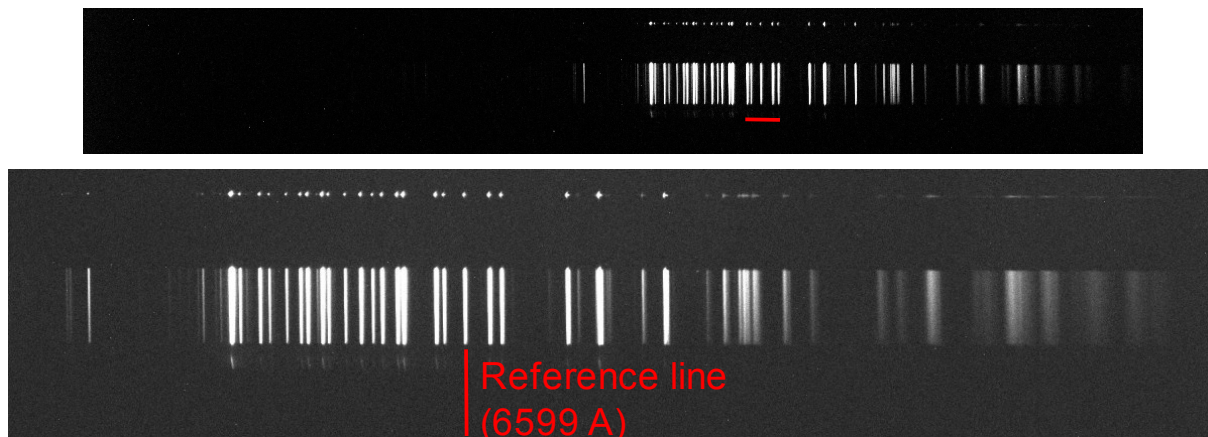

This reference line must be at 2,716mm at the right of the CCD chip center.

Let's take an example :

- We use a QSI583 camera (3326x2504 pixels, 5,4µm).
- The CCD center is at pixel 1663 (= 3326 / 2)
- 2,716mm is 503 pixels (= 2716 / 5,4)
- Then ref line must be at pixel 1663 + 503 = 2166.

Here is the positioning you must have when grating angle is properly tuned (we've shown here several common CCD chips):



## B – Configuration INFRARED

This configuration must be detailed soon.

### 11.6 Appendix F - Tuning the calibration screen

The calibration screen is made to enlight the slit with calibration light sent through the calibration window. The position of the calibration screen is tunable by moving the electro-magnet which control it. If the calibration screen is not properly tuned, the calibration spectra will not be perfectly homogeneous (transversal direction) :



You can see the calibration screen from the to opening of the spectrograph (telescope light entrance). If you activate the screen (plug a 12V power supply in the connector), you'll see the calibration screen moving from release to active position :



The electro-magnet position is given by two screws in slots

> Photo des deux vis de l'électro-aimant, dans deux positions extremes

The tuning procedure is simple :

- Put a cover on the telescope light entrance



- Enlight the calibration window with white light (ideally, tungsten lamp). If you have the calibration module, use the flat lamp.



- Untighten the electro-magnet screws (do not remove them!)



- Move slightly the electro-magnet (using the screws, with the screwdriver)

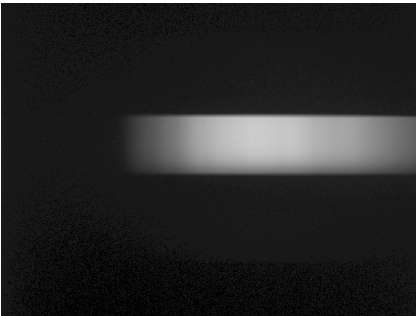
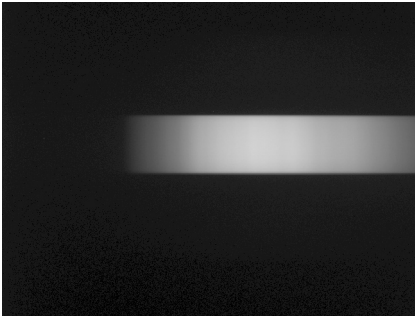
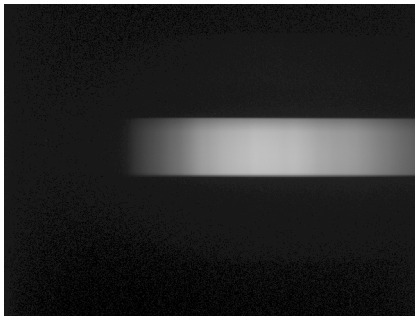

- Take a spectrum and evaluate the homogeneity of the spectrum along the slit. The change is not obvious in the pictures below, but it is more visible in live.

Spectrum too high	Spectrum OK	Spectrum too low
		

- Once you have found the optimal position, tighten the two screws



- Your LISA is ready for calibration spectra acquisition.

### **11.7 Appendix G - Aligning the guiding mirror**

The guiding section of the LISA is made to control that star light comes into the spectrograph through the slit. To work in good conditions, it is key that the telescope axis is seen in the middle of the guiding image. The position of the slit is not tunable in the LISA : the mechanical precision of the parts is enough to ensure that slit is right aligned with the 2" adaptor's axis, then with the telescope.

However, the optical path for guiding image is quite complex, and we must tune the guiding mirror to make the center of the slit in the middle of the image.

The simplest way to tune the mirror angle is to use the tuning slit (with one 19 $\mu$ m hole right in the middle). This device makes very visible where is the center of the slit (which is aligned with the telescope axis).

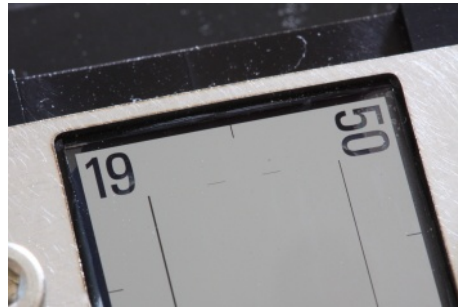
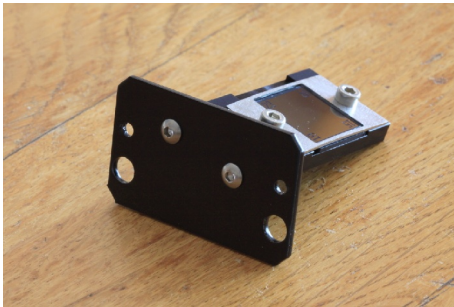

The guiding mirror is mounted on a holder that can be moved with 4 screws, accessible from the telescope light entrance (the guiding mirror cannot be tuned when mounted on the telescope).

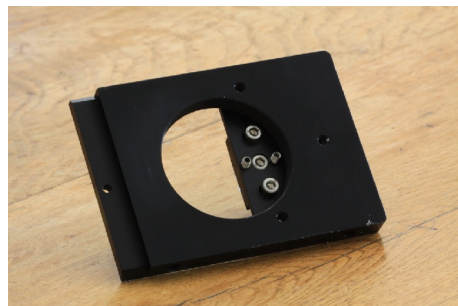
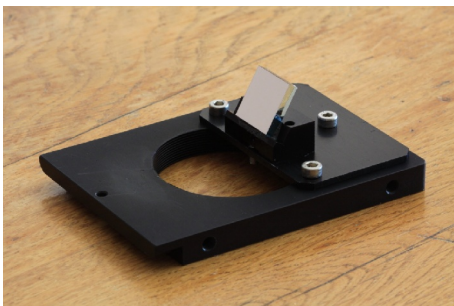

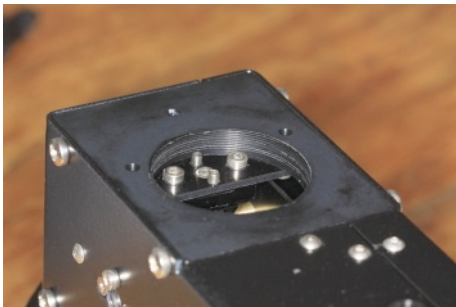

The central screw is a rotating axis : don't remove it.

Here is the procedure to tune the guiding mirror

- Install and switch on the guiding camera. The slit must be well focused, and horizontal.

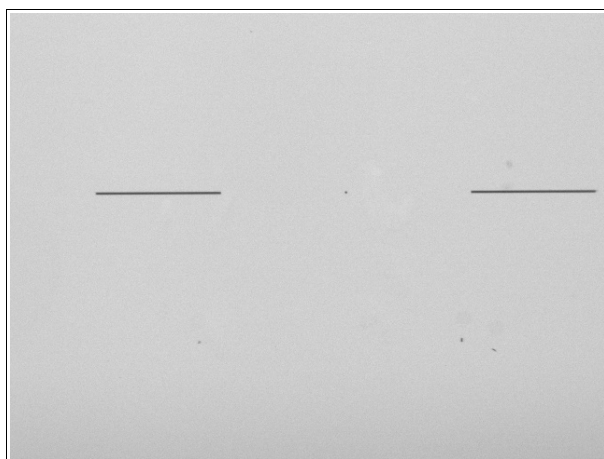

- Untighten the two external screws



- The following pictures show how the guiding mirror holder is made

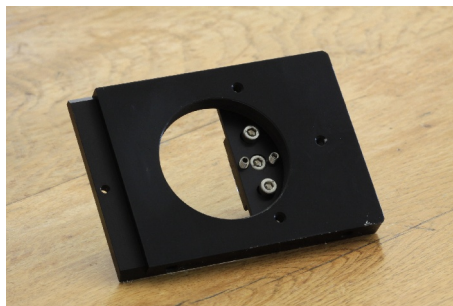
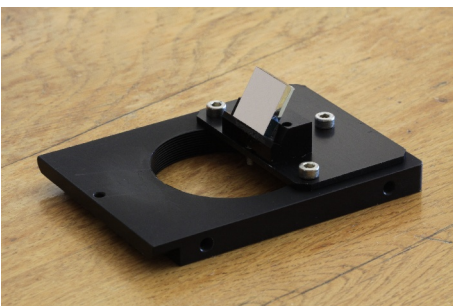

- Rotate the mirror holder around its axis : the slit position will move horizontally

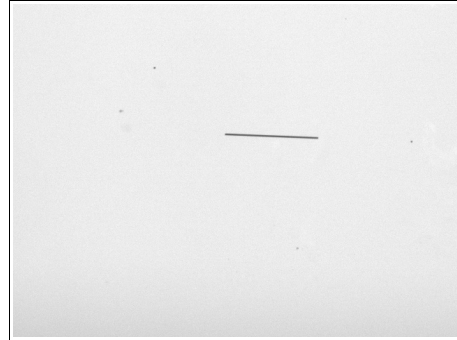
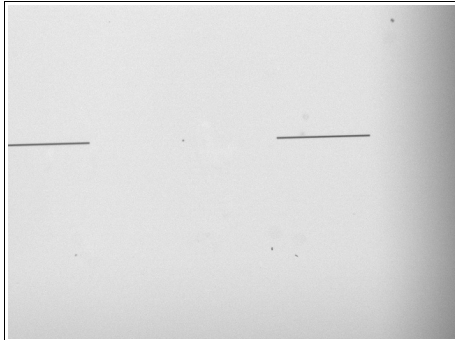
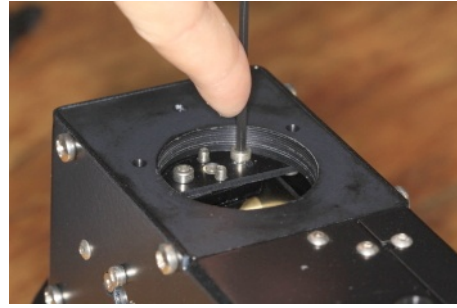
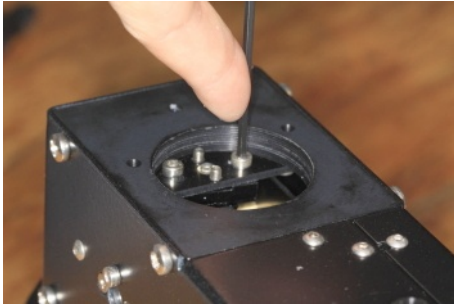

- You can also tune the vertical position of the slit in the image by tightening one of the headless screws. These screws are made to give an angle to the mirror holder

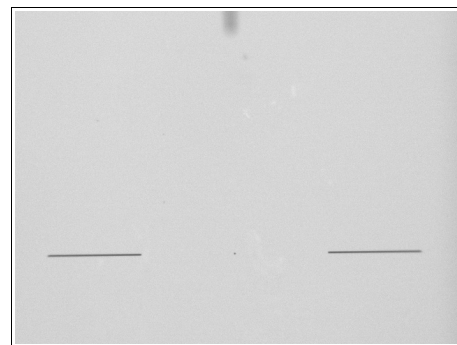
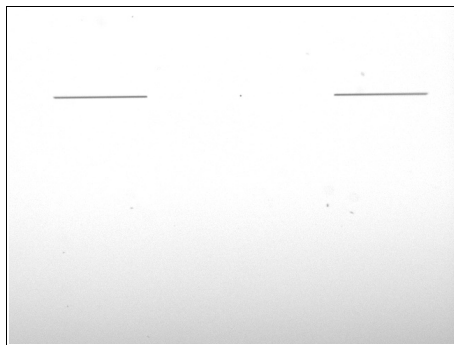
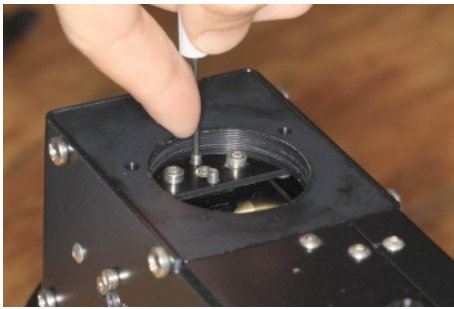

Note : in the last picture on the right (slit in too low position), there is a mark on top side of the screen. This mark is made to show the center of the slit. In some cases, it can be useful to find where is the slit and its center.

- Once you have found the optimal position (hole or center of the slit in the middle of the guiding image, tighten back the two external screws.
- Your LISA guiding mirror is tuned.



## 11.8 Appendix H - Focusing & aligning the collimator

The collimator tuning (focus and alignment) is made in our factory before shipping. But you can, for any reason, want to check or tune it again – this section explains how to do it. Be careful : this is a complex operation, which must be done only by experienced user.

To work in good conditions, the grating must be enlightened by a parallel light beam. This parallel beam is made thanks to the collimator doublet ; the doublet must be perfectly focused on the slit.

To make this operation, you must use the tuning slit (provided as an option by Shelyak Instruments), with a  $19\mu$  hole in the center

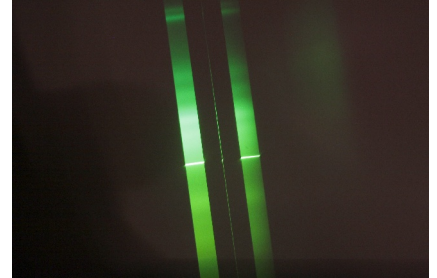
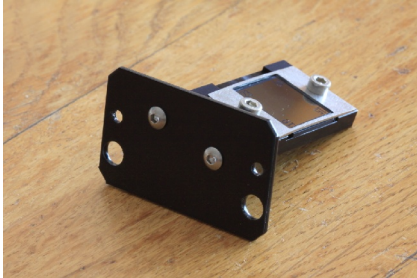

Focusing the doublet can be done this way :

- Open the LISA (see appendix B)
- Remove the grating holder, and put it in a safe place (see appendix C)
- Use any optical device focused at the infinite. It can be a telescope finder (used visually), or the guiding camera with lense focused at the infinite (this is our practice at Shelyak Instruments)
- Look with this optical device through the collimator doublet, towards the main mirror. Align it properly to see the slit.
- Untighten the doublet screw



- Rotate the doublet until the slit image is perfectly focused. Be careful : this process is valuable only if your optical device have been focused at infinite first !



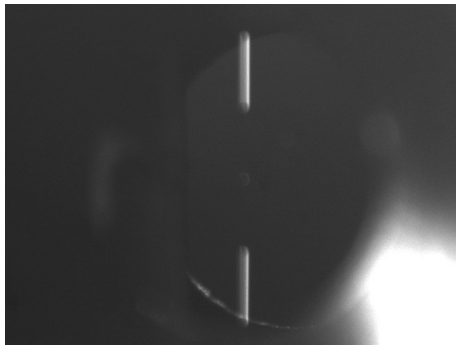

*Slit not focused*

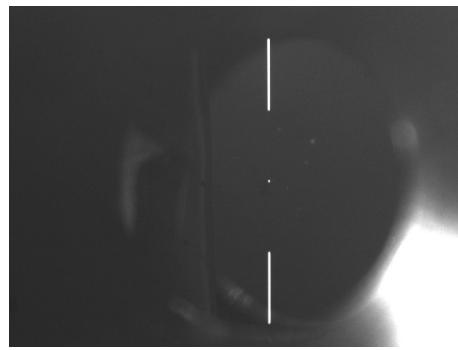

*Slit focused*

- Once the optimal position is found, tighten back the collimator screw

To make the instrument properly aligned, we then must tune the collimator axis towards the slit center. We use an autocollimation process to do it :

- Put all your setup in a dark room (very dark !). Enlight the slit with an intense lamp (for instance, white LED just in front of the slit).

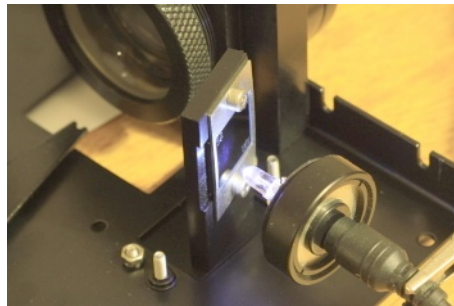

- Put a mirror against the collimator holder

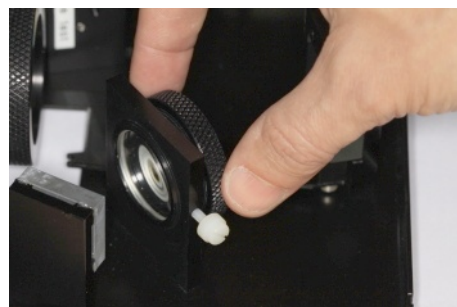

- Look at the slit image, close to the slit itself. When the alignment is correct, both slit and slit image must be confused
- To change the alignment, untighten the collimator holder, and rotate it gently until slit and images are aligned :

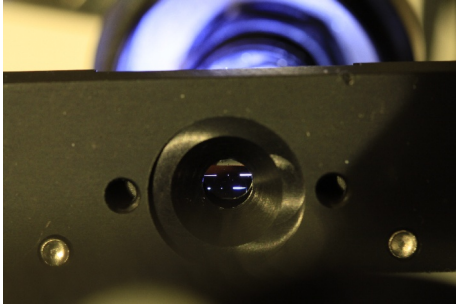

*Collimation not good*

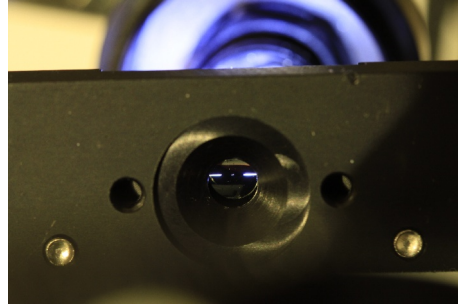

*Collimation Ok*

- If you need to give an inclination angle to the holder, put a small piece of paper between holder and chassis.
- Once the alignment is optimal, tighten back the two collimator holder screws.
- Mount back the grating holder (see appendix C).
- Close the LISA (see appendix B).
- Tune the grating angle (see appendix E).
- Your LISA is ready for observation.

### **11.9 Appendix I - Factory tuning process**

Here is a quick list of all operations that we process in Shelyak Instruments factory before shipping your LISA :

- Collimator doublet focusing and aligning (see appendix H)
- Close the LISA (see appendix B)
- Tune the grating angle (see appendix E)
- Aligning the guiding mirror (see appendix G)
- Tuning the calibration screen (see appendix F)